

Where energies make tomorrow ●

# Technip Energies Technology Handbook

October 2023



TECHNIP  
ENERGIES

# Contents

<b>Sustainable Chemistry</b> .....	<b>7</b>	<b>Ethylene</b> .....	<b>33</b>
<b>Petrochemicals and Polymers</b> .....	<b>9</b>	Ethylene Cracking Furnaces.....	34
Acetic acid .....	10	Low-Emission Cracking Furnace.....	35
Acetone-to-Cumene technology (ATC).....	11	Metathesis.....	36
Benzene conversion (BenzOUT™).....	12	Refinery Off-Gas (ROG) including Ethylene Recovery Unit (ERU) and Propylene Recovery Unit (PRU).....	38
Acrylonitrile butadiene styrene (ABS) .....	13	Ripple Trays™.....	40
Bisphenol A (BPA).....	14	Spent Caustic Technology Unit (Wet Air Oxidation).....	41
CTR® LDPE technology – SABIC .....	15	SPYRO® for Asset Management (SAM®).....	42
Cumene .....	16	SPYRO®, The Steam Cracking Simulation Standard .....	43
Ethylbenzene .....	17	Steam cracking furnaces and product recovery (gaseous feedstocks).....	45
High strength bleach (HSB).....	18	Steam cracking furnaces and product recovery (liquid feedstocks).....	47
Hydrogen chloride oxidation.....	19	Swirl Flow Tube® (SFT®) Furnace Radiant Coils .....	49
Isopropyl alcohol technology (IPA) .....	20	<b>Biochemicals</b> .....	<b>51</b>
Polyamide 6 (PA6).....	21	BioSA – Biosuccinum® .....	52
Polyamide 6.6 (PA6.6) and specialty polyamides .....	22	Brine purification (Pure.rBrine) .....	53
Polybutylene terephthalate (PBT).....	23	Epichlorohydrin (Epicerol®).....	54
Polyethylene terephthalate (PET).....	24	Ethanol to Ethylene (Hummingbird®).....	55
Polystyrene (PS).....	25	Polybutylene adipate terephthalate (PBAT) and Polybutylene succinate (PBS).....	56
Polytrimethylene terephthalate (PTT) .....	26	Polylactic acid (PLAnet™) .....	57
1,3 – Propanediol (PDO).....	27		
Purified terephthalic acid (PTA) .....	28		
Specialty polymers .....	29		
Styrene .....	30		
UNIPOL® Polypropylene Process Technology – GRACE .....	31		
Vinyls chain technologies .....	32		

This document is Technip Energies property and it is -together with the information it contains- confidential. It shall not be used for any other purposes than those for which it was supplied and shall not be reproduced and/or disclosed to any third party without Technip Energies authorization. Technip Energies All rights reserved.

<b>Fertilizers</b> .....	<b>59</b>	<b>Decarbonization Solutions</b> .....	<b>93</b>
Ammonia.....	60	Decarbonization .....	95
Phosphoric acid DH process .....	62	Shell’s CANSOLV CO <sub>2</sub> Capture Technology .....	96
Sulfuric acid production processes (MECS® sulfuric acid technology).....	64	<b>Gas and Low Carbon Energies</b> .....	<b>97</b>
Vacuum table filter (UCEGO®).....	66	<b>Gas Processing/LNG</b> .....	<b>99</b>
<b>Sustainable Fuels</b> .....	<b>67</b>	CRYOMAX® - NGL Recovery Technology.....	100
<b>Biofuels</b> .....	<b>69</b>	HiPur .....	101
BTG Bioliquids.....	70	<b>Hydrogen</b> .....	<b>103</b>
Ethanol.....	72	Hydrogen .....	104
<b>Refining</b> .....	<b>73</b>	Hydrogen and Carbon Capture .....	105
Fluid Catalytic Cracking Resid to Propylene (R2P™).....	74	Syngas (H <sub>2</sub> + CO) .....	106
High Severity Fluid Catalytic Cracking (HS-FCC™).....	76	Co-generation of power.....	107
Progressive Distillation.....	78	Steam Methane Reformer .....	109
PropyleneMax™ Catalytic Cracking (PMcc™) .....	80	EARTH® - Enhanced Annular Reforming Tube for Hydrogen .....	111
<b>Circular Technologies</b> .....	<b>83</b>	TPR® – Technip Energies Parallel Reformer .....	112
<b>Circularity</b> .....	<b>85</b>	Dual Chamber Process Gas Boiler (PGB).....	113
Pure.rGas™.....	86	Ultra Low NOx burners: Technip Side Wall Burner (TSWB®).....	114
Pure.rOil™ .....	88	Ultra Low NOx burners: Large Scale Vortex (LSV) burner.....	115
TruStyrenyx™ Recycled Polystyrene to Styrene Monomer process .....	90	DeNOx using Selective Catalytic Reduction (SCR).....	116
Recycling of Polyamide 6 (rPA) .....	91	Operator Training Simulator (OTS).....	117
		<b>Research Centers</b> .....	<b>119</b>
		Frankfurt, Germany.....	120
		Weymouth, MA USA.....	121

This document is Technip Energies property and it is -together with the information it contains- confidential. It shall not be used for any other purposes than those for which it was supplied and shall not be reproduced and/or disclosed to any third party without Technip Energies authorization. Technip Energies All rights reserved.

# About Technip Energies

Technip Energies is a leading Engineering & Technology company for the energy transition, with leadership positions in LNG, hydrogen and ethylene as well as growing market positions in blue and green hydrogen, sustainable chemistry and CO<sub>2</sub> management.

The company benefits from its robust project delivery model supported by extensive technology, products and services offering.

Operating in 34 countries, our 15,000 people are fully committed to bringing our client's innovative projects to life, breaking boundaries to accelerate the energy transition for a better tomorrow.

Technip Energies is listed on Euronext Paris with American depository receipts ("ADRs"). For further information: [www.ten.com](http://www.ten.com).



This document is Technip Energies property and it is -together with the information it contains- confidential. It shall not be used for any other purposes than those for which it was supplied and shall not be reproduced and/or disclosed to any third party without Technip Energies authorization. Technip Energies All rights reserved.



# What guides us

## OUR DNA •

**An industry pioneer, we are born from a rich history with a clear vision for the future**

We have a passion for excellence and innovation, a commitment to safety and quality. The ability to collaborate and partner, and a desire to build on an already strong track record in energy. Embedded in our culture, our DNA reflects our deep foundation and rich experience.

## OUR PURPOSE •

**Breaking boundaries *together* to engineer a sustainable future**

Our purpose statement captures the essence of who we are and why we do business. It demonstrates our passion and defines what we contribute to the world. It guides us on our mission to design and deliver added-value energy solutions to accelerate the energy transition.

## OUR ESG PLEDGE FOR A SUSTAINABLE FUTURE •

### Together by T.EN

Our ambition is to unleash the talent to resolve complexities, overcome challenges and foster a sustainable ecosystem for industry and the planet. With active participation of our people and our stakeholders, we designed a robust and ambitious ESG roadmap. "Together by T.EN" driven by our four strategic pillars.



This document is Technip Energies property and it is -together with the information it contains- confidential. It shall not be used for any other purposes than those for which it was supplied and shall not be reproduced and/or disclosed to any third party without Technip Energies authorization. Technip Energies All rights reserved.



# Sustainable Chemistry







# Petrochemicals and Polymers



## Application

- Vinyl acetate monomer (VAM)
- Purified Terephthalic Acid (PTA)

## Technology ownership

- FEL contractor for INEOS fully owned/ JV premises

## References

- PRC, 2007, 500 ktpy

## Contact

Cosimo Cannalire  
Head of Win-It Alliances  
cosimo.cannalire@ten.com



# Acetic acid

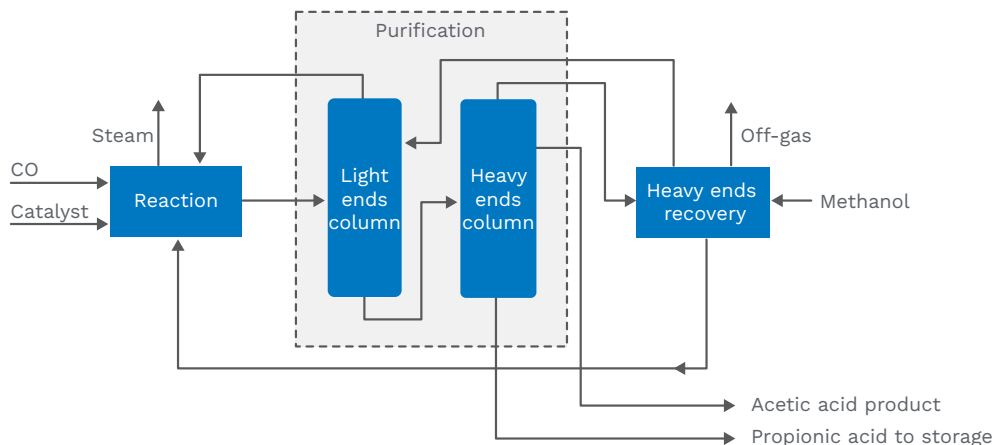

In the CATIVA™ process, acetic acid is produced by continuously reacting carbon monoxide (CO) and methanol (CH<sub>3</sub>OH) in a hydraulically agitated gas-liquid reactor, with a promoted iridium catalyst. Liquid reaction products exit the base of the reactor and are divided into two streams: one used for low pressure steam generation and the second one is flashed and then passes to the Purification Area as vapor feed.

The Purification Area consists of two major columns (Light Ends and Heavy Ends Columns). The main function of the Light Ends Column is to remove methyl iodide, methyl acetate and water, producing crude and dry acetic acid. The Heavy Ends Column removes

light propionic acid and other heavy ends. The pure acetic acid product is withdrawn as a liquid side-draw from the column. The removed heavy ends are then sent to Light Ends Recovery section where methanol is used for scrubbing the process off-gas to recover methyl iodide. BP features a second technology – SaaBre – which is still at pilot plant stage maturity.

### Advantages:

- Variable Cost and Capex reduction, compared to other technologies
- Proved large single train capacity

# Acetone-to-Cumene technology (ATC)

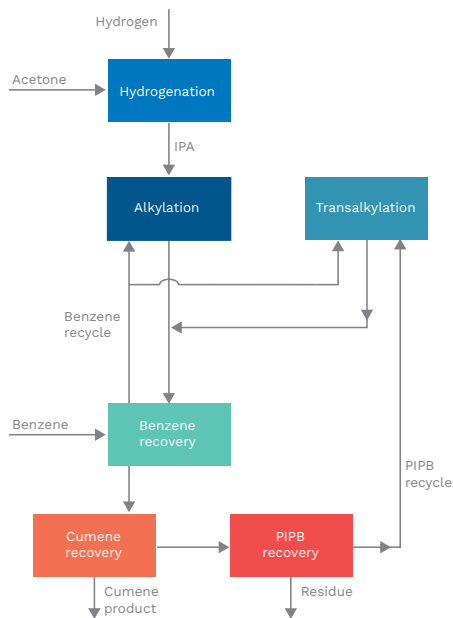

## Hydrogenation

A nickel catalyzed hydrogenation system converts acetone and hydrogen to isopropanol (IPA).

## Alkylation

An alkylation reactor system converts benzene and IPA to cumene in the liquid phase. A small fraction of the cumene is further alkylated to PIPB which will be recovered in distillation and converted to cumene in the transalkylation reactor.

## Transalkylation

A single bed transalkylation reactor converts the small amount of PIPB formed in the alkylator to additional cumene by reaction with benzene in the liquid phase.

## Purification

A simple energy efficient distillation train is used to return excess unreacted benzene to the alkylation and transalkylation reactors, recover cumene product and recycle PIPB to transalkylation.

## Advantages

- Low operating cost
  - Ultra-high (nearly stoichiometric) yields minimize raw material consumptions
  - The alkylation catalyst used can tolerate high water concentration, requiring less circulation
- Superior technology
  - ExxonMobil's proprietary zeolite catalyst does not age due to oligomerization and coking, resulting in long, uninterrupted commercial catalyst cycle lengths
  - High yield – nearly as high as propylene-based zeolite process
- Low capital investment
  - Low benzene to IPA and Bz/PIPB ratios results in smaller reaction and distillation equipment
  - Small catalyst volumes
  - Low temperature, pressure, and non-corrosive conditions allows carbon steel construction

## Application

- Badger ATC technology offers flexibility and can be applied to produce cumene from 100% acetone feed or can be integrated in standard propylene-based cumene plants using partial recycle of acetone from an associated phenol plant.

## Technology ownership

- Technip Energies – Badger Licensing
- ExxonMobil Catalysts and Licensing LLC's zeolite catalyst

## Contacts

Dana Johnson, Licensing Director  
dana.johnson@ten.com

Ken Potochnik, Director Phenolics Licensing  
kenneth.potochnik@ten.com





### Application

- Badger BenzOUT™ reduces benzene in gasoline via a proprietary ExxonMobil alkylation catalyst

### Technology ownership

- Technology originally developed by ExxonMobil
- Technip Energies – Badger Licensing

### References

- 4,000 bpd unit in Newcastle, Wyoming, USA
- 5,500 bpd unit in Superior, Wisconsin, USA

### Contact

Jennifer Muir  
Licensing Manager  
jennifer.muir@ten.com



## Badger Process Technology

# Benzene conversion (BenzOUT™)

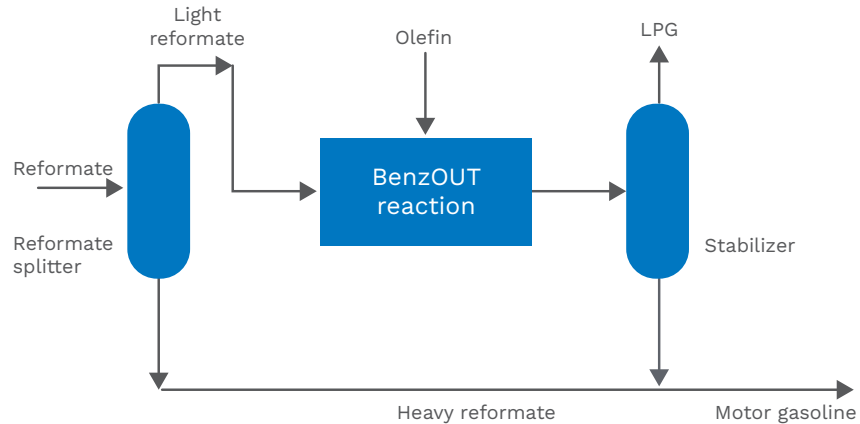

**Badger BenzOUT technology converts benzene typically in a light reformatte stream to higher alkylaromatic components.** The technology can use either Fluid Catalytic Cracker (FCC) propylene or ethylene streams, or a mixture of propylene and butenes as the co-feedstock. Badger BenzOUT technology can be installed as a grassroots unit or it can be retrofitted into an existing facility, such as a catalytic polymerization or saturation unit.

### Advantages

- 95% conversion of benzene in a reformatte stream
- No hydrogen consumption
- Increases octane
- Low temperature liquid phase process
- Gasoline volume swell

# Acrylonitrile butadiene styrene (ABS)

The SABIC proprietary Emulsion ABS Technology requires four main process units; polybutadiene latex (PBL) unit, High Rubber Graft (HRG) unit, Styrene-Acrylonitrile Copolymer (SAN) unit, and the Compounding Unit. The PBL Unit produces polybutadiene latex, an emulsion of polybutadiene rubber in water using four main process operations: feed preparation, reaction, flash removal of unreacted butadiene, and particle size control. The SABIC PBL technology utilizes a 'semi-batch' reaction process where butadiene, water, emulsifier, and additives are initially charged in the reactor at a relatively low percentage of the total reaction volume and then continuously added throughout the reaction cycle. The result is a faster batch time reaction and a safer reaction process where stopping the feed stops the reaction process without risk of runaway reactions. After reaction and removal of unreacted butadiene, the PBL is sent to a mechanical particle size control unit operation resulting in a PBL with a desirable particle size distribution. The final PBL intermediate product is combined with styrene, acrylonitrile, and additives in the HRG unit reaction process. The HRG reaction process utilizes the same 'semi-batch' technique as the PBL unit reaction. The reaction step is followed by a continuous coagulation and drying process to form resin particles and dry the HRG product. The SAN product is produced in parallel to the HRG product in a single agitated reactor. The SAN unit includes feed filtration, bulk reaction, devolatilization, unreacted monomer recovery, and SAN product pelletizing. Finished ABS product is formulated in the Compounding unit using

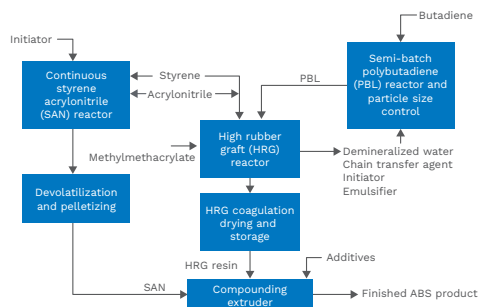

an extruder package. An automated feed system delivers HRG resin, SAN pellets and preblended additives to the extruder. The extruder system includes a screen changer, strand die, water slide, pelletizer, pellet dryer, water recirculation system and screener. After screening, the pellet material is transferred to product surge hoppers and packaging.

Key features of the SABIC ABS Technology include:

- Inherently safe reaction processes, low reaction viscosities
- High process yields
- Competitive capital and operating costs
- Single poly butadiene latex and high-rubber graft product results in simplified operation
- Exceptional product quality with a broad family of products meeting most demanding application requirements. Custom high heat grades with Polycarbonate blends are available for license.
- Optimized impact-flow performance with low organic volatiles and non-polymer impurities
- Additive flexibility enables specialty products from natural/black/white and custom colors

## Application

- Acrylonitrile butadiene styrene (ABS) is a key thermoplastic used in the electronics, appliances, building, construction and transportation industries. The properties of ABS can be widely varied by using different concentrations of butadiene rubber and acrylonitrile in the copolymer.

## Technology ownership

- Proprietary SABIC technology
- Technip Energies is exclusive licensor

## References

- Tianjin Dagu, Phase I at 200,000 MTA, startup Q4 2010 and Tianjin Dagu, Phase II at 200,000 MTA, startup Q4 2011
- FEED Development for Petrokemya 2011 and Petrokemya at 140,000 MTA, startup Q1 2016
- Undisclosed Client, 200,000 MTA, PDP Engineering started Jan 2020

## Contacts

Dana Johnson  
Licensing Director  
dana.johnson@ten.com

Peter Vallieres  
ABS Licensing Manager  
peter.vallieres@ten.com



## Application

- Badger's BPA technology produces high-purity bisphenol A (BPA) product suitable for polycarbonate and epoxy resin applications. BPA is produced over ion exchange resin catalyst from phenol and acetone in a process featuring proprietary purification technology.

## Technology ownership

- Technip Energies – Badger Licensing

## References

- Demonstrated performance with 14 licensed BPA plants in commercial operation with installed capacity of 2.0 million tpy

## Contacts

Dana Johnson  
Licensing Director  
dana.johnson@ten.com

Kenneth Potochnik  
Director Phenolics Licensing  
kenneth.potochnik@ten.com

## The Badger Bisphenol A (BPA) process



LG Chem, Yeosu, Korea

## Badger Process Technology

# Bisphenol A (BPA)

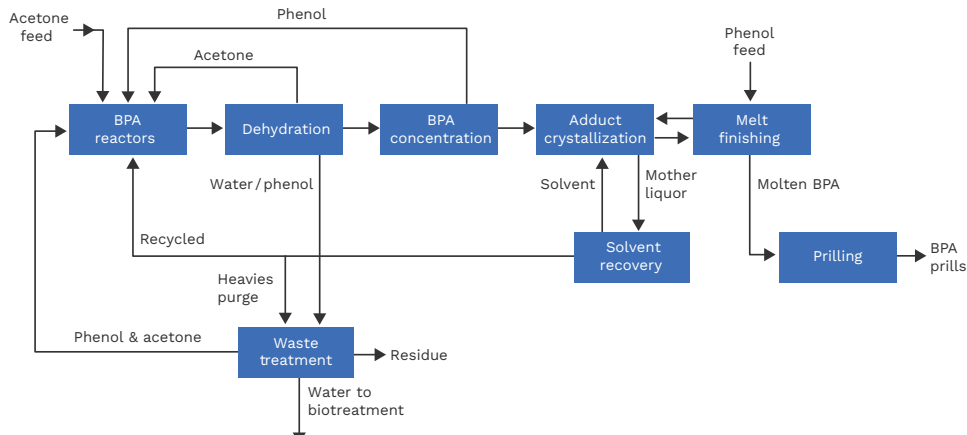

**converts commercial-grade phenol and acetone into high-purity BPA suitable for polycarbonate, epoxy resin, and other chemical applications.** The acetone and phenol are reacted by condensation in an acidic ion exchange resin-catalyzed reactor system to produce BPA, water and various byproducts. Water and unreacted acetone are removed through distillation. The acetone and lights are absorbed into phenol and recycled to the reaction system. The bottoms are sent to the crystallization feed pre-concentrator which removes phenol and concentrates BPA to a level suitable for crystallization. BPA is separated from byproducts as a BPA-phenol adduct in a proprietary evaporative crystallization and recovery system. A mother liquor from the purification system is distilled to recover dissolved coolant. The distilled mother liquor stream is recycled to the

reaction system. Residue recovery and dephenolation systems recover phenol and acetone from the heavies purge and water streams. The purified adduct is processed in a BPA finishing system to remove phenol from product, and the resulting molten BPA is solidified in the prill tower to produce product suitable for the merchant BPA market.

## Advantages

- 99.95% p,p-BPA purity
- Excellent product color
- Superior catalyst economics
- Exceptionally high yield
- Global product acceptance by polycarbonate producers
- Demonstrated operational reliability

# CTR<sup>®</sup> LDPE technology – SABIC

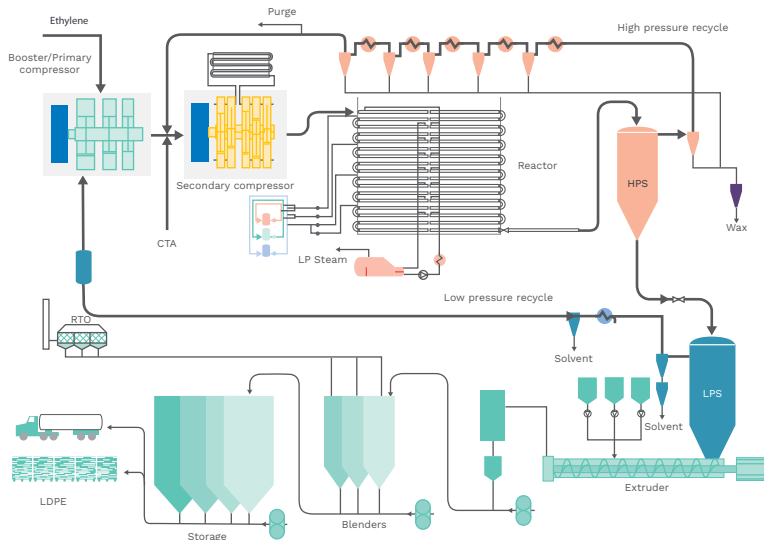

**The Clean Tubular Reactor Technology is a non-pulsing technology where ethylene is polymerized through a radical reaction initiated by peroxides at a pressure of approximately 2500 bar in a tubular reactor.**

The reactor is a plug flow type reactor. Not all the ethylene is converted into polymer on the first pass. The unconverted monomer is recycled to the compression section and the produced LDPE, as a melt, is extruded.

## Advantages

The Clean Tubular Reactor technology presents many differentiators: high conversion per pass, low CAPEX per installed capacity, energy integration, high raw material efficiency, robust intrinsic safe design to control unlikely runaway reaction, low operating pressure vs. competition.

## Application

- Low density polyethylene is a polyolefin resin plastic used globally in a wide range of market segments including packaging, consumer products, agriculture and general industrial. High value extrusion coating grades may be produced on tubular technology.

## Technology ownership

- Technip Energies is the exclusive licensing support contractor of SABIC for the Clean Tubular Reactor LDPE technology.

## References

- More than 10 plants in operation.
- Eight references were designed by Technip Energies.

## Contact

Cédric Allemand  
Licensing Manager  
cedric.allemand@ten.com



## Application

- Produced from benzene and any grade of propylene (including lower-quality refinery propylene-propane mixtures)
- Using of our proprietary process and zeolite catalysts from ExxonMobil

## Technology ownership

- Technip Energies – Badger Licensing
- ExxonMobil Catalysts and Licensing LLC (EMCL)

## References

Twenty-eight licensed plants in commercial operation

- Licensed capacity currently in commercial operation > 10,000 KTA
- Six licensed plants in various stages of development will add nearly 2800 KTA
- Single train capacities as large as 750 KTA have been licensed and demonstrated
- Badger technology can produce high quality cumene from any commercial grade of propylene
- Badger technology has successfully supplied cumene to all major downstream phenol processes

## Contacts

Dana Johnson  
Licensing Director  
dana.johnson@ten.com

Kenneth Potochnik  
Director Phenolics Licensing  
kenneth.potochnik@ten.com



## Badger Process Technology

# Cumene

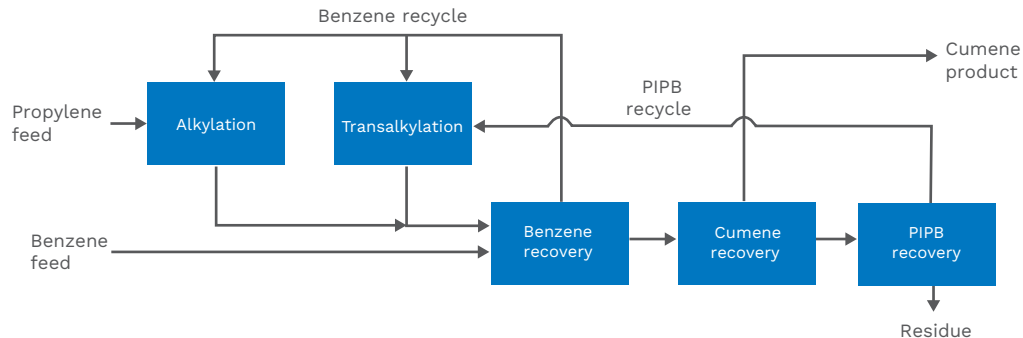

**The process includes three sections: a fixed-bed alkylation reactor, a fixed-bed transalkylation reactor and a distillation unit.** Liquid propylene and benzene are premixed and fed into the alkylation reactor, where the propylene is completely reacted. In the transalkylation reactor, recycled polyisopropylbenzene (PIPb) is premixed with benzene, where PIPb reacts to form additional cumene. The transalkylation and alkylation effluents are then fed to the distillation unit. During recovery, there are four separate processes occurring: a depropanizer recovers propane overhead as LPG, a benzene column recovers excess benzene to be recycled to the reactors, a cumene column recovers cumene product overhead, and a PIPb column recovers PIPb overhead for recycling to the transalkylation reactor.

## Advantages

- Low capital investment
  - Low B/P and Bz/PIPb ratios results in smaller reaction and distillation equipment

- Small catalyst volumes
- Low temperature, pressure, and non-corrosive conditions allow carbon steel construction
- Low operating cost
- Ultra-high (nearly stoichiometric) yields minimize raw material consumptions
- Low B/P and Bz/PIPb ratios minimize utility and power consumptions
- EMCL's zeolite catalyst does not require hot benzene washes or special procedures to restore catalyst activity



# Ethylbenzene

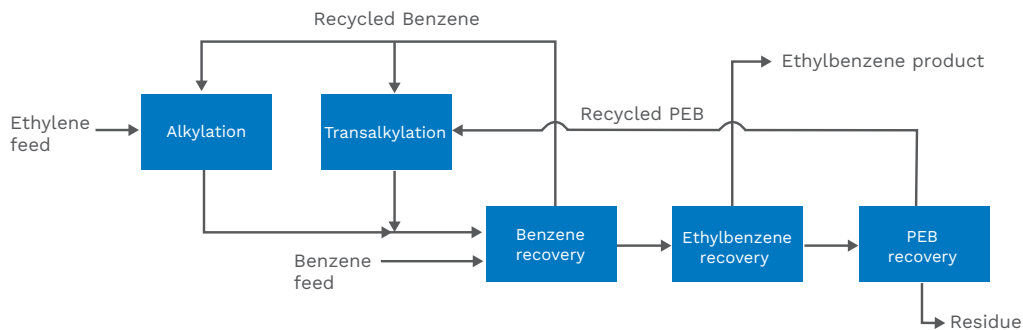

Ethylene reacts with benzene in either a totally liquid-filled or mixed-phase alkylation reactor (1) containing multiple fixed beds of ExxonMobil's proprietary catalyst, forming EB and very small quantities of polyethylbenzenes. In the transalkylation reactor (2), polyethylbenzenes are converted to EB by reaction with benzene over ExxonMobil's transalkylation catalyst.

## Advantages

- Low variable operating costs
- Low initial capital investment
- The reaction system produces less than 100 ppm of impurities boiling in the range of EB, resulting in EB product purities in excess of 99.97 wt%
- The catalyst does not age due to coking caused by ethylene oligomerization

## Application

- The production of ethylbenzene (EB) from benzene and a polymer-grade ethylene, or an ethylene/ethane feedstock using the Badger EBMax™ process and proprietary ExxonMobil alkylation and transalkylation catalysts

## Technology ownership

- Technip Energies – Badger Licensing

## References

- As of early 2022, Badger has licensed plants representing over half of the world's ethylbenzene having a total installed capacity of more than 25 million mta
- Single trains as large as 1.4 million mta have been demonstrated

## Contact

Dana Johnson  
Licensing Director  
dana.johnson@ten.com

Grant Donahoe  
Director Styrenics Licensing  
grant.donahoe@ten.com



## Application

- HSB is used in different bleaching processes as standard bleach

## Technology ownership

- Proprietary ARKEMA technology
- Technip Energies has an exclusive licensing agreement with ARKEMA

## References

- 1 reference unit at Arkema
- 3 licensed units in Olin (USA)

## Contact

Jean-Christophe Millet  
Licensing Manager  
jean-christophe.millet@ten.com



# High strength bleach (HSB)

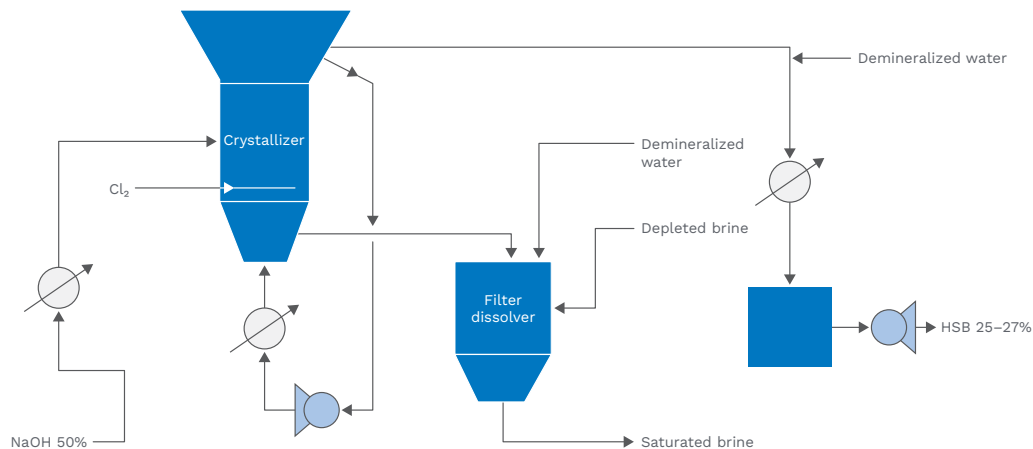

Chlorination reactor in Arkema plant (France)



Chlorination reactor in Olin plant (USA)

**HSB (25-27% NaClO) is produced by the reaction of Cl<sub>2</sub> gas and 50% NaOH solution in a reactor/crystallizer. The result of the chemical reaction also by-produces solid salt (NaCl) which is recycled in electrolysis as raw material.**

The obtained HSB contains much less salt than standard one per ton of active chlorine.

## Advantages

- Compared to the standard bleach (12% NaClO), the HSB is more concentrated (25-27%)
- Reduction of the transportation cost and the added water/salt in process



# Hydrogen chloride oxidation

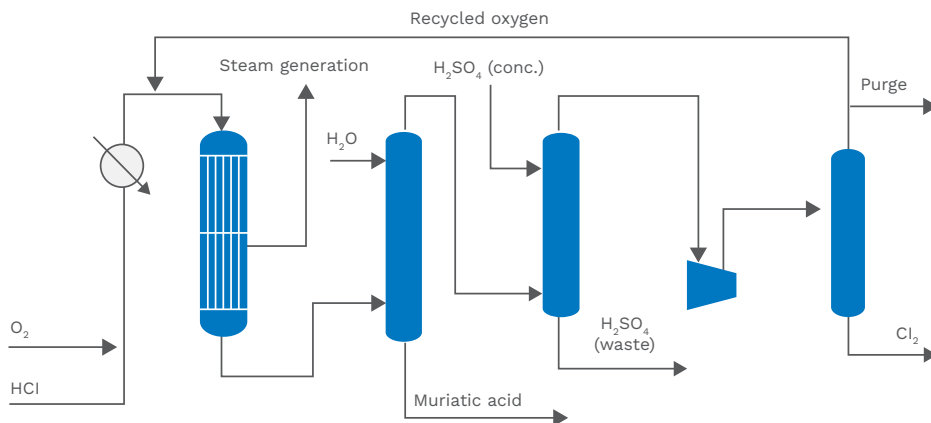

**The HCl Oxidation process catalytically converts the HCl byproduct in plant into useful chlorine and to minimize the import of expensive chlorine.** The process uses a commercially proven catalyst in a fixed-bed tubular reactor, which is followed by a washing and distillation process. Feeds of O<sub>2</sub> and HCl are heated and mixed with recycled O<sub>2</sub>. The reactor effluent consists of mostly HCl, O<sub>2</sub>, Cl<sub>2</sub> product and steam, and is cooled and washed to remove any unreacted HCl. The HCl-free reactor effluent gas is then washed with sulfuric acid to remove any moisture. The remaining stream, consisting of Cl<sub>2</sub>, O<sub>2</sub> and minor inerts, is then compressed and separated into a chlorine product and O<sub>2</sub> recycle stream. The high-purity chlorine product is vaporized and superheated for reuse.

The reactor effluent consists of mostly HCl, O<sub>2</sub>, Cl<sub>2</sub> product and steam, and is cooled and washed to remove any unreacted HCl. The HCl-free reactor effluent gas is then washed with sulfuric acid to remove any moisture. The remaining stream, consisting of Cl<sub>2</sub>, O<sub>2</sub> and minor inerts, is then compressed and separated into a chlorine product and O<sub>2</sub> recycle stream. The high-purity chlorine product is vaporized and superheated for reuse.

## Advantages

- Low variable operating cost
  - Unit consumption of electrical power is very low compared to unit consumption by the electrolysis method
  - Total power and steam consumption per ton of chlorine produced is less than competing technologies
- Superior technology
  - Produces chlorine with comparable purity to that produced by brine electrolysis but with lower operating costs
  - High catalyst activity and long life

## Application

- The HCl Oxidation technology produces a high purity chlorine, while offering an economical and highly reliable operation that uses little power and steam
- The unique technology developed by Sumitomo Chemical Company offers a robust process using an active and thermally stable catalyst

## Technology ownership

- Proprietary Sumitomo Chemical technology
- Technip Energies is exclusive licensor

## References

- Ten trains of HCl Oxidation have been licensed in the world, with a total production capacity of 1000 ktpy

## Contacts

Erik Moy  
Licensing Manager  
erik.moy@ten.com

Dana Johnson  
Licensing Director  
dana.johnson@ten.com



## Application

- Badger IPA has viricidal and bactericidal properties, which make it an effective antiseptic.

## Technology Ownership

- Technip Energies – Badger Licensing

## References

- Badger's IPA process has been licensed eight times for a total licensed capacity of 480 KTA. Three units are commercially operating and five units are in design.

## Contacts

Dana Johnson, Licensing Director  
dana.johnson@ten.com

Ken Potochnik, Director Phenolics  
Licensing  
kenneth.potochnik@ten.com



## Badger Process Technology

# Isopropyl alcohol technology (IPA)



**Crude IPA is produced as an intermediate stream in Badger's Acetone-to-Cumene (ATC) technology via the hydrogenation of acetone.** Typically, in the ATC process, the IPA is then alkylated with benzene in a reaction step to produce cumene. However, for our process that produces IPA, the IPA intermediate is purified and becomes the final product.

### Hydrogenation

A hydrogenation system converts acetone and hydrogen to isopropyl alcohol (IPA). The hydrogenation reactor operates in the mixed phase, trickle bed flow regime. Acetone and hydrogen feedstocks enter the reactor and react on a supported nickel catalyst. The effluent from hydrogenation flows to downstream processing for purification of the IPA product.

### Purification

The feed to purification is a stream containing primarily isopropyl alcohol and water at a composition close to their low boiling azeotrope.

The product separation is accomplished using simple distillation, with fewer columns than other technologies. The product is a commercial grade IPA product that conforms to the ASTM D-770 specification. There is also a small vent stream and a small wet purge leaving the purification system.

### Advantages

- IPA unit can be integrated into existing cumene-phenol plants to produce a cumene product if combined with IPA alkylation
- Can be a standalone IPA unit producing commercial grade IPA product
- Enables phenol producers to balance solvent production
- Low capital investment and operating cost
- Small catalyst volume in hydrogenation reactor
- Simple distillation scheme to purify the IPA product
- High yield and low energy consumption

# Polyamide 6 (PA6)

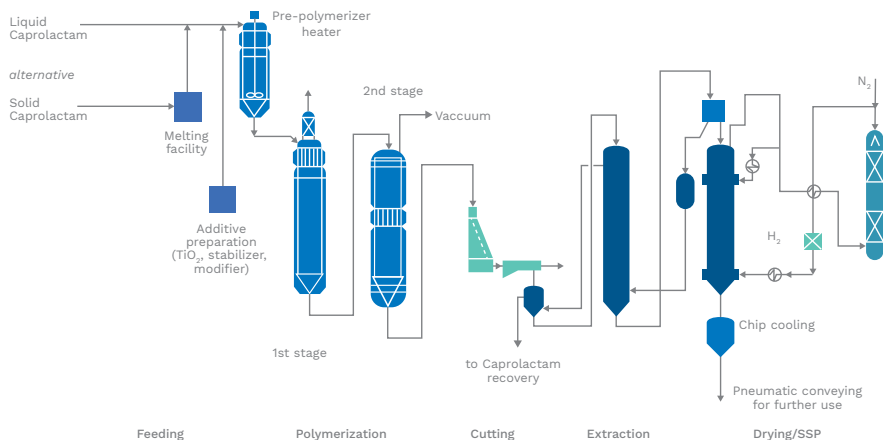

As a first step of Polyamide 6 production, caprolactam feedstock is fed to the pre-polymerizer for ring opening reaction and initial polymerization. Depending upon the final application additives are introduced and the melt is transferred to the final polymerizer where the polymer chains grow to reach the desired melt viscosity. The melt is then cult into chips which pass through an extraction column where the monomers and oligomers are removed.

Finally, water is removed in a drying section and optionally the viscosity is raised further via a solid-state polymerization (SSP). For film applications we provide dry-blending technology. The removed monomers and oligomers are recycled via our caprolactam recovery system (CRS). The recovered caprolactam is reused as feedstock for high quality applications.

## Advantages

- High raw material efficiencies
- Low consumption of utilities
- Minimal waste
- Proven technology for minimization of capital and maintenance costs
- In-line compounding (latest development) for high operation flexibility with various products out of the polymerization line

## Application

- Textile and industrial filaments, carpet and tire cord yarn
- Engineering plastic
- Film applications

## Technology ownership

- Proprietary Technip Energies technology

## References

- More than 160 tailor-made plants built since 1953
- Standard capacities ranging from 100 – 390 tpd

## Contact

Stefan Deiss  
 Head of Product Management and R&D  
 stefan.deiss@ten.com



## Application

- High Temperature Engineering plastics
- Automotive Applications
- Conveyor belts

## Technology ownership

- Proprietary Technip Energies technology

## References

- First Zimmer® PA6.6 batch plant started up in 1965
- Various possible capacities (1 – 100 tpd) based on the recipe and target viscosity

## Contact

Stefan Deiss

Head of Product Management & R&D  
stefan.deiss@ten.com



Zimmer® Polymer Technologies

# Polyamide 6.6 (PA6.6) and specialty polyamides

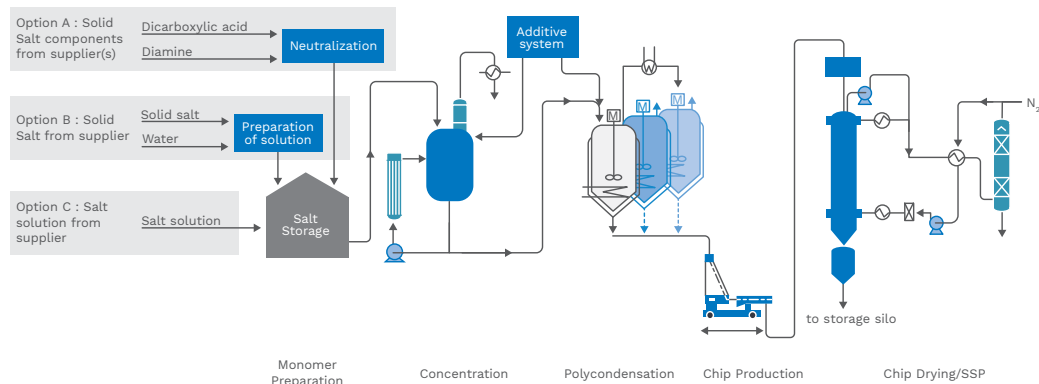

To produce polyamide 6,6 an AH-salt solution is either created from the monomers adipic acid (ADA) and hexamethylenediamine (HMD) or dissolving solid AH-Salt with water. This polyamide salt solution is added to the concentration unit where the water is evaporated to increase the salt concentration. It is then transferred to the autoclave where the polycondensation reaction takes place. Additives can be blended into the melt in the concentration unit and the polycondensation unit depending on the application. Multiple autoclaves operating in parallel, enable high production throughput where the final melt viscosity is achieved via solid-state polymerization (SSP).

## Advantages

- Enhanced daily production with multiple autoclaves.
- Self-cleaning, energy efficient reactor.
- Sophisticated agitator enables wide range of specialty polyamides, including PA (5,6), PA (6,10) & PA (6,12)

# Polybutylene terephthalate (PBT)

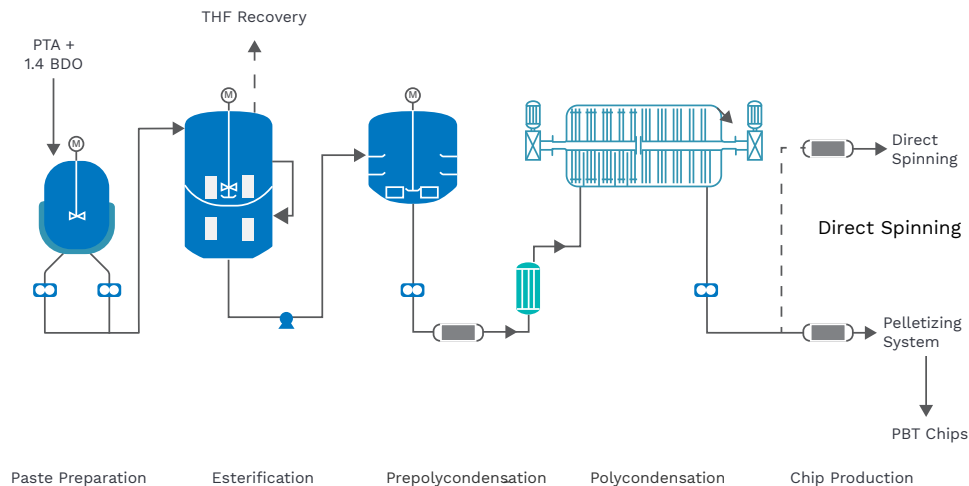

In our three-reactor process, PBT is produced starting with 1.4-butane diol (BDO) and purified terephthalic acid (PTA). After paste preparation, the raw materials are esterified to bis-hydroxybutylterephthalate (BHBT) and oligomers, while water/THF are split off. The reaction continues in a prepolycondensation stage and is finished in the final reaction step. Zimmer’s proprietary Double Drive Reactor (DDR) is incorporated to create the desired high viscosity that is required followed by a pelletizing system. Direct spinning is also possible considering the residence time of the polymer and the design of the piping. The valuable side product, THF, is purified to a high quality, pharmaceutical-grade product which has a wide range of applications from solvents over reaction agents to monomers.

## Advantages

- Unique reactor design enables development of a highly efficient process for high viscosity melt
- Reliable and cost effective plants
- Exceptionally high yield of the required feedstock 1.4 butane diol (BDO) and purified terephthalic acid (PTA)

## Application

- Offers superior strength and durability compared to other polyesters
- Outstanding chemical resistance and physical properties
- Especially suitable for applications in engineering plastics, automotive and high-value textiles

## Technology ownership

- Proprietary Technip Energies technology

## References

- Zimmer’s PBT technology accounts for approximately 70% of the plants built worldwide in the last decade

## Contact

Stefan Deiss  
 Head of Product Management and R&D  
 stefan.deiss@ten.com



## Application

- Most recognized, used and versatile polymer
- Designed using a three or four-reactor process (depending on capacity)
- Zimmer® technology offers a low process temperature with fewer byproducts and an excellent polymer quality
- Depending on the final application, various co-monomers and/or special catalysts will be used
- Vary from textile/bottle/film grade for the packing industry to engineering plastics for the automotive industry

## Technology ownership

- Proprietary Technip Energies technology

## References

- More than 195 PET polycondensation plants with total capacity of about 13 mta
- 48 PET bottle grade resin plants with total capacity of about 5 mta
- Global market share of about 20%

## Contact

Stefan Deiss

Head of Product Management and R&D  
stefan.deiss@ten.com



Zimmer® Polymer Technologies

# Polyethylene terephthalate (PET)

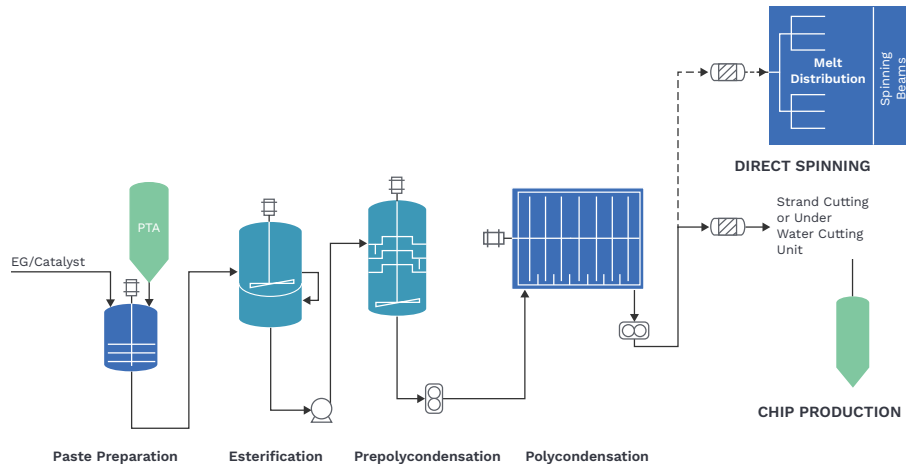

**In our three-reactor process, PET is produced starting from ethylene glycol (EG) and purified terephthalic acid (PTA).** The raw materials including co-monomers, are esterified in a two-stage reactor, transferred through a Prepolycondensation step and finalized in our proprietary Disc Ring Reactor (DRR). Our robust disc ring reactor design is based on decades of experience, in-depth research and development and technological expertise. This proprietary reactor system, available as single- or double-drive, guarantees a smooth and reliable operation with a high viscosity lift and/or large capacities followed by a pelletizing system. Direct spinning is also possible considering the residence time of the polymer and the design of the piping. Additionally, PET flakes also can be added to the esterification or polycondensation.

## Advantages

- Higher viscosity lift
- Lower process temperatures
- Lower thermal stress and product degradation
- Exceptional availability and reliability
- Feed of FDA approved PET flakes
- Lower energy consumption and costs by using crystal cut, direct high intrinsic viscosity and dealdehydization process

# Polystyrene (PS)

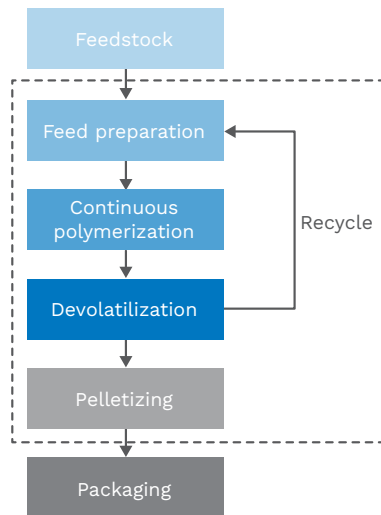

**TotalEnergies' state-of-the-art Polystyrene Technology is based on a continuous mass process that utilizes proprietary polymerization reaction steps.** TotalEnergies' Polystyrene Technology is capable of General Purpose Polystyrene (GPPS) and High Impact Polystyrene (HIPS) grades. A single Polystyrene production line can have a capacity up to 250,000 MTA. The lines can be designed to produce GPPS or HIPS grades exclusively or produce a combination of GPPS and HIPS grades on a 'swing' line, where production lots can shift back and forth between GPPS and HIPS, depending on end customer requirements. For GPPS production, styrene monomer, additives and white oil are sent to a feed mix tank.

For HIPS, polybutadiene rubber bales are first ground and then dissolved in styrene monomer (SM). The HIPS or GPPS feed solution are preheated upstream of the polymerization reactors. The reactor configuration depends on the product slate and plant capacity. Devolatilization is accomplished in a two-stage deep vacuum system. Polymer melt from the last reactor is preheated upstream of the first devolatilizing step, where unreacted SM and ethylbenzene solvent are stripped. The second devolatilizer operates at very low absolute pressure, reducing residual SM to values as low as 150 ppm. A vacuum system is used to cool vapors from the reactors and devolatilization systems. Vapors are condensed in water-cooled exchangers, collected in a surge drum and recycled to the reactor system. Devolatilized polymer melt is sent to a pelletization unit operation. The TotalEnergies' polystyrene technology offers several types of palletization operations specifically to suit the need of each polystyrene producer. After the pelletization process, cool, dry pellets are classified and stored.

Key features of the TotalEnergies' Polystyrene Technology include:

- Continuous mass polymerization process
- Low capital investment
- Low operating and maintenance cost
- Superior product performance
- Diverse polystyrene grade available for license including high transparency GPPS, High Gloss, and high ESCR, and
- Operational experience of high safety and environmental standards.

## Application

- Polystyrene (PS) is used in the electronics, appliances, building, food service, construction, and transportation industries.

## Technology ownership

- Proprietary TotalEnergies technology
- Technip Energies is exclusive licensor

## References

- TotalEnergies' Polystyrene technology has been installed in over 50 units in 20 countries
- The largest single polystyrene production line in the world is owned and operated by TotalEnergies in their Carville, LA, USA facility
- TotalEnergies is the owner and operator of four polystyrene plants worldwide with an aggregate capacity of 1,035,000 MTA
- TotalEnergies has experience retrofitting existing polystyrene units
- Licensed polystyrene with two 100,000 MTA 'swing' lines to an undisclosed client in China in 2017

## Contact

Dana Johnson  
Licensing Director  
dana.johnson@ten.com

Peter Vallieres  
Polystyrene Licensing Manager  
peter.vallieres@ten.com





# Polytrimethylene terephthalate (PTT)

## Application

- Mainly produced to satisfy market demand for textile properties
- Resin is stain and static resistant with excellent performance in carpet, business textiles and high-end engineering plastics

## Technology ownership

- Proprietary Technip Energies technology

## References

Montréal, Canada, 300 tpd, 2004

## Contact

Stefan Deiss  
Head of Product Management and R&D  
stefan.deiss@ten.com

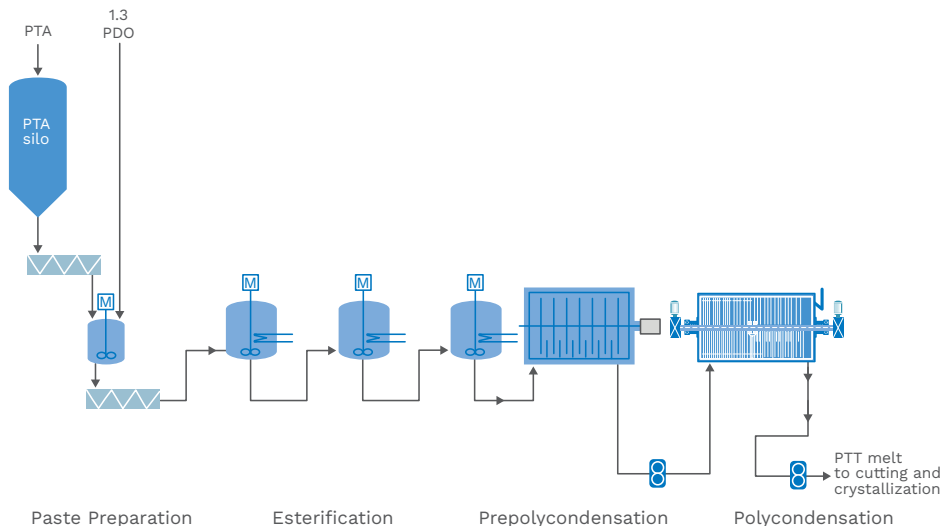

**Our PTT process is based on 1,3-propanediol (PDO) and purified terephthalic acid (PTA) as feedstock.** The raw materials are esterified in a two-stage reactor system. Polycondensation reaction takes place in the following prepolycondensation reactor and the final reaction step to reach the desired high viscosity is done in Zimmer's® Double Drive Reactor (DDR). This proprietary double-drive reactor system guarantees a smooth and reliable operation at high viscosity and large capacities. All reactors and overhead systems are designed to ensure safe operation, considering the environmental issues associated with the side products Allyl alcohol and Acrolein.

## Advantages

- Fully integrated 1,3-PDO recovery
- High product quality at highest utilization of raw materials
- Flexible viscosity outlet by using Zimmer's® DDR



PTT Poly Canada, Montréal, Canada

# 1.3 – Propanediol (PDO)

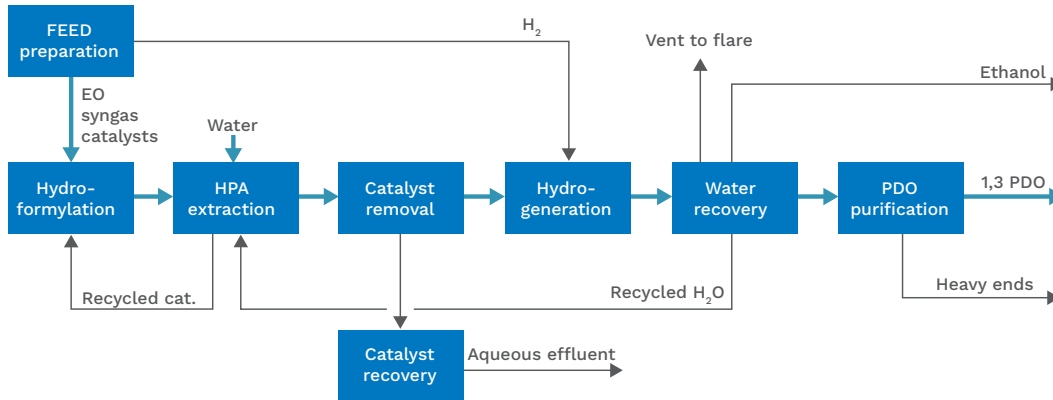

In the first step of the 1,3-propanediol process, a catalyzed hydroformylation takes place: ethylene oxide reacts with carbon monoxide and hydrogen to 3-hydroxypropionaldehyde (HPA). After extraction of the intermediate product with water, the catalyst is removed and recycled. In the following HPA reacts catalytically with hydrogen in aqueous phase by forming the crude product 1,3-propanediol. In a next step water is removed and reused for the extraction step. Finally the light ends (ethanol) and heavy ends (derivatives of 1,3-propanediol) are withdrawn by distillation to obtain the pure product 1,3-propanediol.

### Advantages

- A continuous process with low operating cost
- Large single line capacities
- Stable and high product quality at highest utilization of raw materials
- EO and Syngas as feedstocks are easily available

### Application

- Mainly used as raw material to produce polytrimethylene terephthalate (PTT)
- PDO can be formulated into a variety of industrial products including polyurethanes, copolyesters, paints, lubricants and coatings. It also has the potential to be used in cosmetic and daily care applications

### Technology ownership

- Proprietary Technip Energies technology

### References

- Developed by Shell Chemical and acquired by Technip Zimmer®
- Realized the first kind of this unit in Geismar, Louisiana, USA (75 kt/y capacity as a pioneer of the technology) in 2001

### Contact

Stefan Deiss  
Head of Product Management and R&D  
stefan.deiss@ten.com





# Specialty polymers

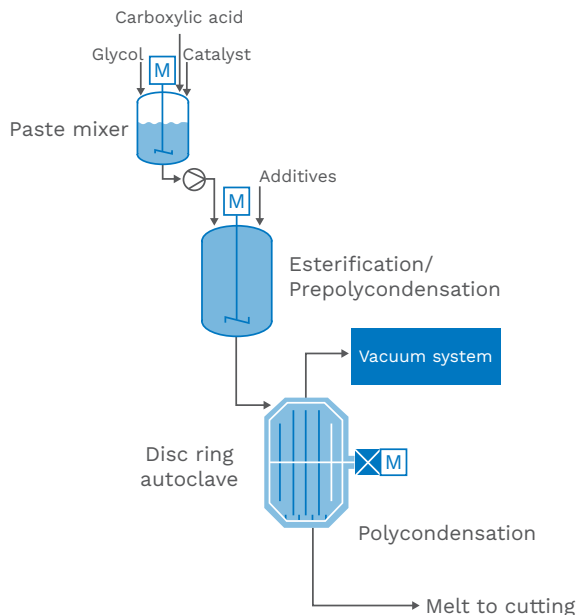

The specialty polyesters are based on a **carboxylic acid and glycol as the main feedstock. Both are mixed while catalyst/additives are added in the paste preparation vessel. From there the paste is fed into the Esterification/Prepolymerization reactor.** This step is controlled using a special temperature/pressure regime and additives can be fed as required per recipe. The split-off vapors are released from the esterification stages and fed into the process column for rectification. The intermediate polymer product is then transferred to the Disc Ring Autoclave for final polymerization. This proprietary reactor enables a maximum evaporation surface due to high surface renewal, low process temperature, short polycondensation time and therefore low thermal stress.

### Advantages:

- Variation of carboxylic acids and alcohols is possible
- High viscosities for different applications via the disc ring autoclave

### Application

- Adaptable technology to produce a variety of polymers such as PCT, TPEE, PEN or PET containing various additives and co-monomers
- Tailor-made process for the specific requirements up to a capacity of 12.5 metric tons per batch

### Technology ownership

- Proprietary Technip Energies technology

### References

- Plant in South Korea
- PEN plant in USA

### Contact

Stefan Deiss  
 Head of Product Management and R&D  
[stefan.deiss@ten.com](mailto:stefan.deiss@ten.com)



## Application

- Badger styrene monomer (SM) is manufactured by dehydrogenating ethylbenzene (EB) to styrene
- The feedstock EB is produced by alkylating benzene with ethylene using the EBMa<sup>x</sup>™ process

## Technology ownership

- Proprietary TotalEnergies technology
- EBMa<sup>x</sup>™ is a trademark of ExxonMobil Corporation
- Technip Energies is exclusive licensor

## References

- As of early 2022, Badger has licensed plants representing almost half of the world's styrene manufactured by ethylbenzene dehydrogenation
- Badger styrene technology has been selected for use in more than 50 units having design capacities (single-train) up to 770,000 mta

## Contacts

Dana Johnson  
Licensing Director  
dana.johnson@ten.com

Grant Donahoe  
Director Styrenics Licensing  
grant.donahoe@ten.com



## Badger Process Technology

# Styrene

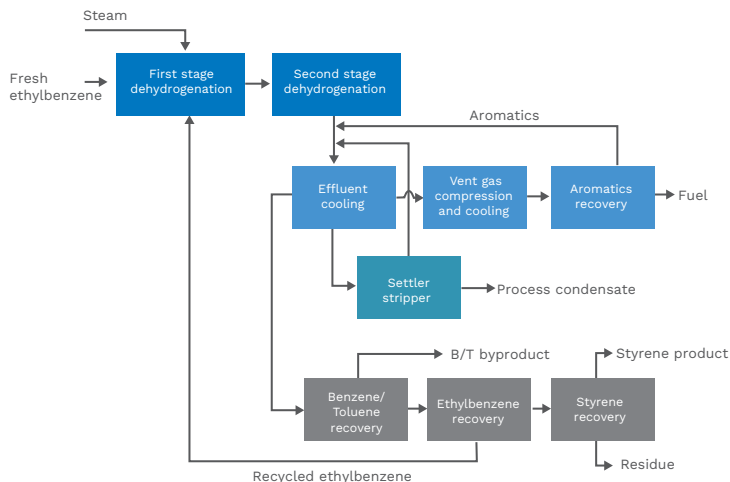

**Ethylbenzene (EB) is dehydrogenated to styrene over potassium-promoted iron oxide catalyst in the presence of steam.** The endothermic reaction occurs under vacuum conditions and high temperature. At a 1 weight ratio of steam to EB feed and a moderate EB conversion, reaction selectivity to styrene is approximately 97%. Byproducts benzene and toluene are recovered via distillation, with the option of recycling the benzene.

## Advantages

- Demonstrated superior mechanical integrity
- External reactor reheat exchanger for easy access and maintenance
- Vertical feed/effluent exchanger provides constant pressure drop and compact design
- Low steam superheater outlet temperatures
- Multi-effect distillation significantly reduces energy consumption



# UNIPOL® Polypropylene Process Technology – GRACE

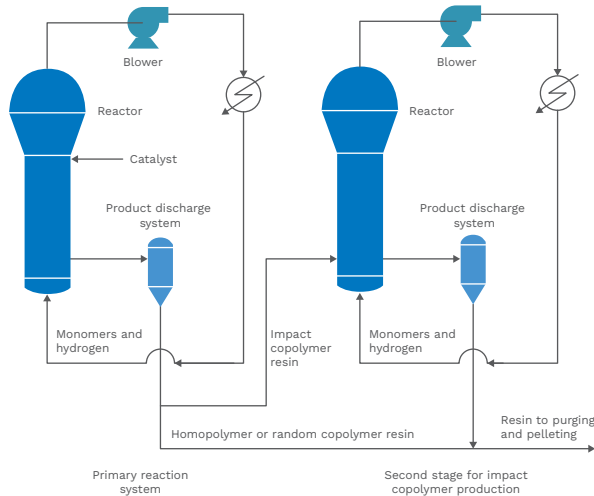

**The UNIPOL® Polypropylene Process Technology is a comprehensive technology and licensing services packages that combines product and catalyst know-how.**

The UNIPOL® PP process technology is simple mechanical process consisting of one or two gas phase fluidized bed reactors where propylene is catalytically polymerized into homopolymer, random or impact copolymer resins.

A minimal amount of major equipment is required. There are only three or four pieces of major rotating equipment depending on production configuration.

## Advantages

An all gas-phase technology based on a fluidized bed reactor system, UNIPOL® PP process technology is designed to have fewer moving parts and less equipment than any competing technology. The simple, reliable design of UNIPOL® PP process and related PP product technology, coupled with SHAC® catalyst systems and the new CONSISTA® catalyst systems, offers another significant economic benefit – the ability to operate the plant above nameplate capacity.

The simplicity of the homopolymer/random copolymer systems is also mirrored in the impact copolymer state. It uses the same gas-phase fluidized bed process with a slightly smaller reactor.

## Application

- Polypropylene is a polyolefin resin generally considered as a commodity plastic. It is used globally in a wide range of market segments including packaging, consumer products, building and construction. Niche high value grades are also found in the automotive industry.

## Technology ownership

- W. R. Grace & Co.
- Technip Energies is an engineering support contractor of GRACE for UNIPOL® PP technology. Technip Energies is an approved FEED and EPC contractor for Grace® technology.

## References

- More than 61 polypropylene plants in operation
- More than 26 licensed polypropylene lines in design & construction

## Contact

Cédric Allemand  
Licensing Manager  
cedric.allemand@ten.com



GRACE®, CONSISTA® and SHAC® are trademarks, registered in the United States and/or other countries, of W. R. Grace & Co.-Conn. TALENT | TECHNOLOGY | TRUST™ is a trademark of W. R. Grace & Co.-Conn. UNIPOL® and UNIPOL UNIPPAC® are trademarks of The Dow Chemical Company or an affiliated company of Dow. W. R. Grace & Co.-Conn. and/or its affiliates are licensees to use the UNIPOL® and UNIPOL UNIPPAC® trademarks in the area of polypropylene. This trademark list has been compiled using available published information as of the publication date and may not accurately reflect current trademark ownership or status. All pictures and diagrams © Copyright 2020 W. R. Grace & Co.-Conn. All rights reserved.

## Application

- Polyvinyl chloride (PVC) is the world's third most largely produced synthetic polymer.
- It is a chlorinated polymer fabricated from ethylene and salt.
- The rigid form of PVC is primarily used in construction industry for pipe and profile applications such as doors and windows.
- It can be made softer and more flexible by the addition of plasticizers.

## Technology ownership

- Licensing Support Cooperation with Oxyvinyls for transformation of ethylene and chlorine to EDC /VCM
- Licensing Support Cooperation with Kem One for transformation of VCM to PVC

## References

- More than 40 EDC/VCM and PVC units
- RusVinyls Integrated Vinyls Complex, Russia. 350 kta

## Contact

Jean-Christophe Millet  
Licensing Manager  
jean-christophe.millet@ten.com



# Vinyls chain technologies

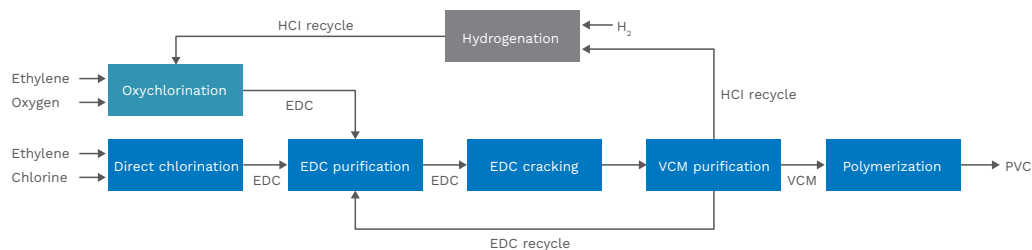

**Ethylene dichloride (EDC) is produced by direct chlorination of ethylene and then purified before being cracked to the Vinyl Chloride Monomer (VCM) in the EDC cracking furnaces.** The produced VCM is further purified before sent to the polymerization unit to produce PVC. Recovered Hydrogen chloride (HCl) is hydrogenated to removed acetylene and fed to the oxychlorination section. Together with fresh ethylene and oxygen, EDC is produced in the oxychlorination reactor which is fed to the cracking furnaces as well as EDC from direct chlorination. The process can be balanced in HCl or can produce HCl for export. In case of no local chlorine production, the direct chlorination can be replaced by imported EDC. The high purity VCM is polymerized in the reaction section and then dried and conditioned to produce solid PVC powder.



Kem One PVC, Balan, France



# Ethylene



## Application

- Thermal cracking of a wide range of feedstocks into light olefins, including ethylene, propylene, butadiene and aromatics, using proprietary cracking coils.

## Technology ownership

- Proprietary Technip Energies technology

## References

- Since 2000, our furnace technology has been implemented in more than 200 gas cracking furnaces and more than 190 liquid cracking furnaces.

## Contact

Jim Middleton

Ethylene Product Line Leader

jim.middleton@ten.com



# Ethylene Cracking Furnaces

USC®, SMK™, GK®

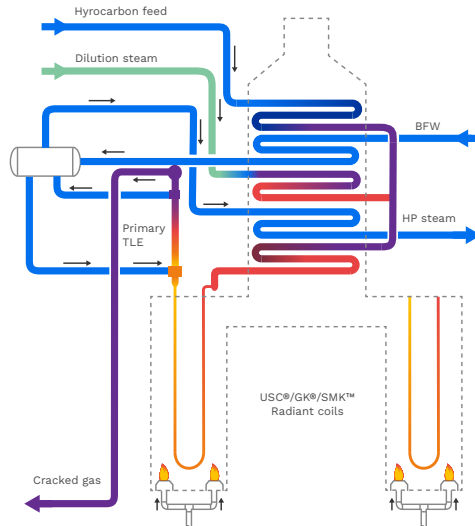

**Traditional thermal cracking occurs in the presence of steam at high temperature in cracking coils located centrally in the firebox.** Coil outlet temperature varies from 800°C to 880°C, depending on feed type and cracking severity. The proprietary coils most commonly used are the GK6® and USC®-U for liquids cracking, and USC®-M, USC®-W and SMK™ coils for gas cracking. They feature high selectivity to ethylene and propylene, together with low coking rates (longer run length). More recently, we have developed new patents (Three Lane Coils and Swirl Flow Tubes [SFT®]) to improve furnace capacity and run length at a lower investment cost.

Within the cracker, gases from the furnace coils pass through a transfer line exchanger (TLE) system, where heat is recovered to generate high-pressure steam. The TLEs are specialized shell-and-tube or linear exchangers that provide low to very low fouling rates, thereby extending run lengths. In the convection section, heat from the flue gases is recovered to preheat feed and process steam, to preheat boiler feed water and to superheat the generated high-pressure steam.

This same technology is also applied to retrofit furnaces. Our proprietary SPYRO® software allows operators to optimize the furnace performance. Various options of NOx abatement can be incorporated to comply with regulatory requirements.

## Advantages

Performance data:

- |   |          |
|---|----------|
| • Ethane conversion                     | % 65–75  |
| • Naphtha cracking severity (P/E ratio) | 0.4–0.75 |
| • Overall thermal efficiency            | % 92–95  |
| • Coil residence time, sec              |          |
| • GK6®/USC®-U                           | 0.15–0.3 |
| • SMK™/USC®-M/USC®-W                    | 0.3–0.6  |

# Low-Emission Cracking Furnace

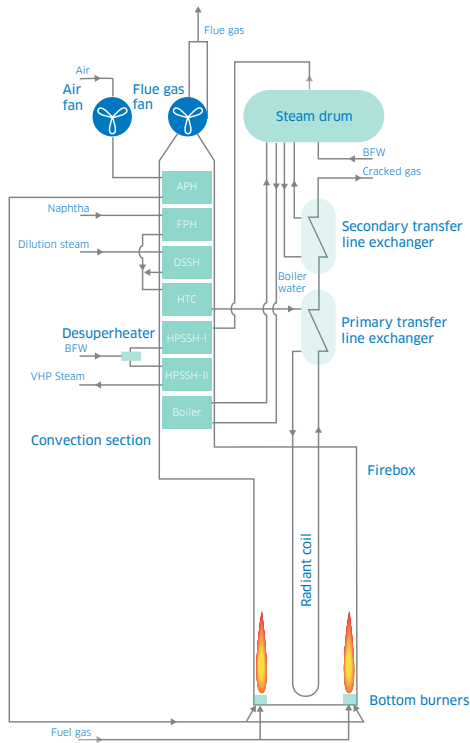

Low-emission cracking furnace with air preheat.

**The heat recovery scheme of the conventional furnace configuration limits the extent to which the fuel efficiency can be improved.** To overcome this limitation, Technip Energies has developed a new heat recovery scheme.

Various high efficiency configurations are available, including:

- Air preheat
- Full oxyfuel combustion
- Partial oxyfuel combustion

The novel low-emission cracking furnace flow sheet involves as a key element, a feed-effluent exchanger. This exchanger performs the final superheating of the hydrocarbon feedstock/dilution steam mixture in a primary transfer line exchanger (TLE), which heats up the hydrocarbon feedstock against the cracked gas.

## Low-Emission Cracking Furnace advantages:

- Reduces the fuel consumption by approximately 30 percent by raising the furnace firebox efficiency by roughly 30 percent
- A 30 percent fuel reduction results in a 30 percent reduction of CO<sub>2</sub> emissions at the ethylene furnace stack as firing is reduced.
- Cost-effective design with a pay-back time of approximately one year

## Application

A novel proprietary cracking furnace design to significantly increase fuel efficiency and reduce CO<sub>2</sub> emissions.

By modifying the heat recovery scheme, fuel consumption and the associated CO<sub>2</sub> emissions can be reduced by 30 percent. This is a suitable solution for green field plants, furnace revamps or addition of furnace units in existing assets.

## Technology ownership

- Proprietary Technip Energies technology (patent filed)

## Contact

Peter Oud, Product Development Manager Ethylene  
[peter.oud@ten.com](mailto:peter.oud@ten.com)



## Application

Metathesis is used for propylene production from C4-olefinic derivative stream. Olefin metathesis, or disproportionation, provides an opportunity to achieve olefin interchangeability. Many reactions are prone to happen between any olefin to produce a new olefin. Reactions are all equilibrium based reactions which take place in presence of catalyst. The equilibrium depends on three criteria: the species present, their stoichiometry and operating conditions.

The primary metathesis reaction is the reaction of butene-2 with ethylene to produce propylene. Polymer-grade propylene (> 99.9 percent mol) can then be recovered in the downstream recovery section.

## Technology ownership

- Technip Energies Process Technology licensing
- Clariant MetaMax® Catalyst

## Contact

Jim Middleton  
Ethylene Product Line Leader  
jim.middleton@ten.com



# Metathesis

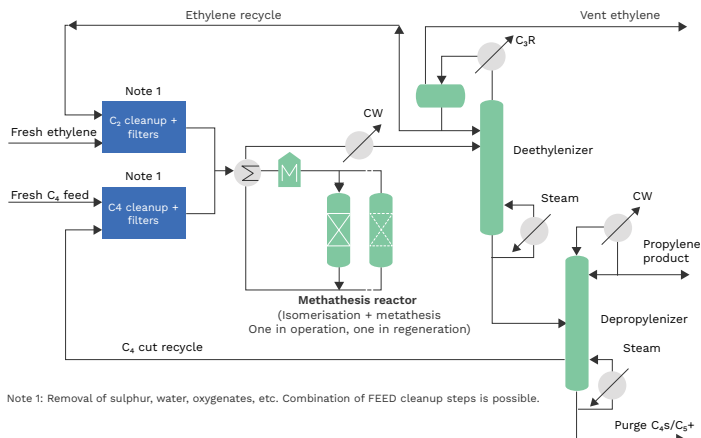

**Downstream of impurities removal beds (which remove poisons, such as oxygenates, water, sulfur), the combined ethylene and C4 feed is heated before it enters the metathesis reactor.** The butene once-through conversion is limited by equilibrium, while here an excellent ATE (approach to equilibrium) of >98 % will be achieved. The metathesis catalyst exhibits a selectivity towards propylene of >96 %, while the variations depend of the feedstocks applied.

The effluent from the metathesis reactor contains mainly unreacted ethylene, propylene, butenes, paraffinic C4, C5 and heavier components. This stream is cooled before being fractionated in two distillation columns (deethylenizer/depolymerizer) to produce polymer-grade propylene.

The deethylenizer requires cryogenic conditions at top and overhead stream (ethylene) is recycled to

the reactor. The depolymerizer is fully condensed against cooling water. A C4 side-draw dedicated to recycling unconverted butenes to the metathesis reactor is extracted in the lower part of the column. The bottom product, which purges the system, forms the heaviest product and the components that cannot react (mainly the paraffinic C4). It is convenient to route this byproduct stream to a steam cracker or to send it to the gasoline pool of the refinery.

## Main operating parameters

- Reaction temperature 300–350°C
- Reaction pressure 30–35 bar(g)

## About Catalyst

- Mixture of a tungsten oxide catalyst (dedicated to metathesis) and of a magnesium oxide catalyst (dedicated to isomerization of 1-butene to 2-butene)
- Regeneration: Nitrogen/air/hydrogen

## Advantages

Metathesis has major advantages compared to other propylene production processes:

- Direct production of polymer-grade propylene without installation of a costly C3 splitter column
- Very low quantity of byproducts
- Valorization of C4 cut feedstock

Benefits of the metathesis process using Clariant's MetaMax® catalyst solution include:

- High feed flexibility — applications include steam cracker, FCC off-gas, MTO and C5s
- High tolerance to butadiene
- Nearly no effect from i-butene
- High propylene yields and selectivity
- Low C5+ byproduct make
- Outstanding stability and long operating cycles
- Good mechanical resistance prevents dust and related pressure drop
- Robust to multiple regeneration cycles.

## Integration with an ethylene cracker or refinery

Since polymer-grade ethylene feed is required, the metathesis process is fully utilized when integrated in a steam cracker plant. The integration of the two units into one relies on synergies, which lower the investment cost per ton of olefins produced. Integration with refineries, in combination with an ethylene recovery unit, can significantly increase the value of refinery streams by production of olefins.

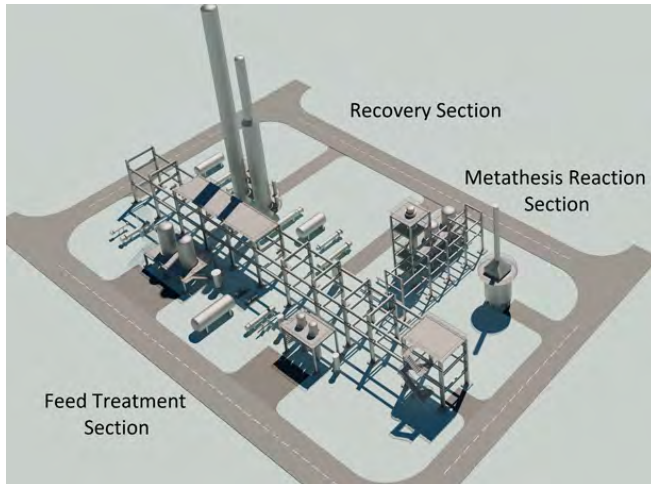



## Application

ROG technology, which allows the production of valuable polymer-grade ethylene and propylene, can be classified in two categories:

- The unsaturated off-gas coming from fluidized catalytic cracking (FCC), deep catalytic cracking (DCC) or Coker units is rich in ethylene and propylene
- The saturated off-gas coming from other refining units can be rich in ethane and propane; the recovered ethane and propane are then cracked to produce ethylene and propylene

The ROG contains many light components (nitrogen, hydrogen and methane) and contaminants requiring dedicated treatment. An ROG unit provides a level of purity that allows either direct production of polymer grade products or further processing in an ethylene plant recovery section.

## Technology ownership

Proprietary Technip  
Energies technology

## References

- More than 17 ROG / ERU / PRU units are in operation
- ROG Project for Reliance Industries Limited in India is an example of ethylene production at world-scale capacity (1.4 MMtpy) using only refinery off-gas as feedstock.

# Refinery Off-Gas (ROG) including Ethylene Recovery Unit (ERU) and Propylene Recovery Unit (PRU)

## Unsaturated ROG Scheme:

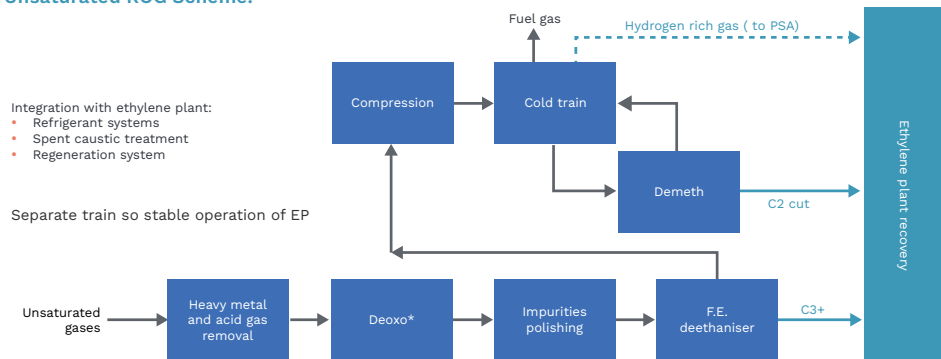

## Saturated ROG Scheme:

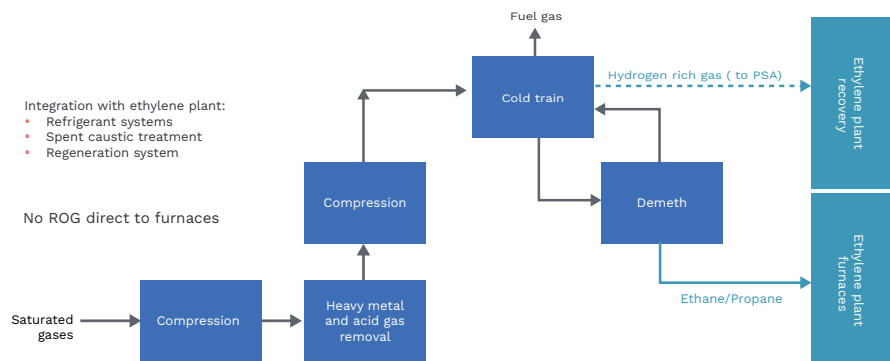

The ROG unit is broken down into sections including feed contaminant removal and ethylene and propylene recovery. Feed contaminants including heavy metals, acid gases, oxygen, NOx, arsine, mercury, ammonia, nitrites, COS, acetylene, chloride and water must be removed. The designer of the unit must be experienced with feedstock pre-treatment since many trace components in the ROG can impact product quality, catalyst performance and operational safety.

The ROG unit can include an ethylene recovery section that produces either dilute ethylene or polymer-grade ethylene (referred to as an Ethylene Recovery Unit or ERU). Otherwise, the purified C2 cut/C3 cuts are routed into the steam cracking plant for further purification and recovery. Depending on the capacity constraints of the steam cracker or the off-gas quantity of nitrogen, hydrogen and methane, the ROG unit may include a cold box followed by a Demethanizer and C2/C3 separation.



#### Advantages

- ROG streams (often unsaturated gases from FCC, DCC and Coker units) contain a significant amount of ethylene and propylene. Normally, these streams are used as fuel gas in the refineries. Recovery of the olefins can be economical, with project payout duration of often less than one year.
- It is economical to treat the saturated gases with a relatively large amount of ethane and propane for further cracking and production of ethylene and propylene.

#### Contact

Jim Middleton  
Ethylene Product Line Leader  
jim.middleton@ten.com





## Application

Proprietary separation trays serving the chemical, petrochemical, and refining industries

## Technology ownership

Technip Energies proprietary technology

## References

Advanced tower performance in nearly 500 applications worldwide

## Contacts

Tim Cook  
Process Technology Manager  
tim.cook@ten.com

Joel Guillaume  
Director Technology  
joel.guillaume@ten.com

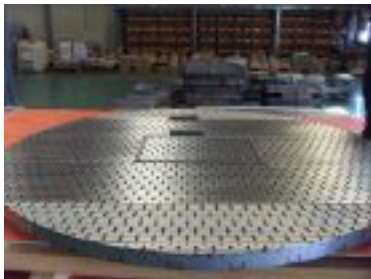

# Ripple Trays™

High-capacity Ripple tray optimizes separation due to liquid and vapor-handling properties

Tray spacing

Corrugated tray deck

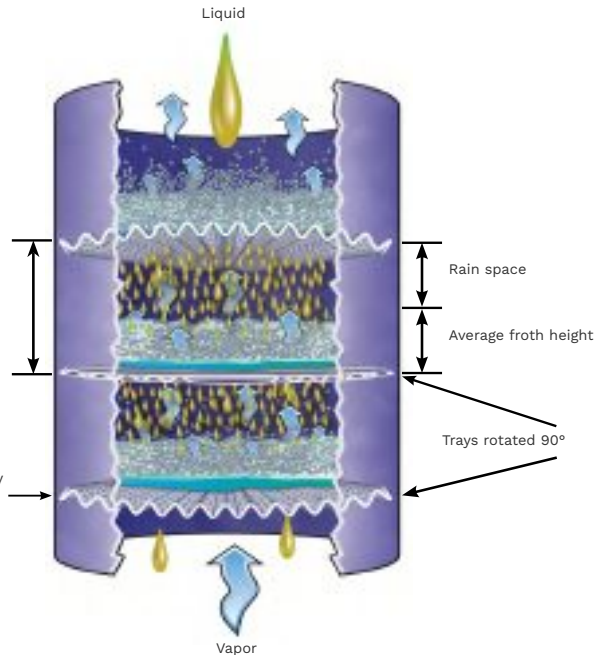

**Ripple Trays have been proven for distillation, absorption, stripping, and heat transfer service in towers up to 40 feet (12 meters) in diameter.** By optimizing liquid and vapor handling, the trays enable significant capacity increases over conventional trays. In addition, the continuous agitation of the liquid on the top side of the trays, combined with continuous underside wetting/washing action, makes them ideal for fouling services. Tray designs covering a range of applications are available.

Compared to conventional trays, Ripple Trays can easily increase column capacity by 40 percent or more. The Ripple Tray has superior ability to combat fouling without associated vapour / liquid maldistribution. The combination of turbulence on the tray deck with continuous washing of the bottom surface eliminates stagnation on the trays.

# Spent Caustic Technology Unit (Wet Air Oxidation)

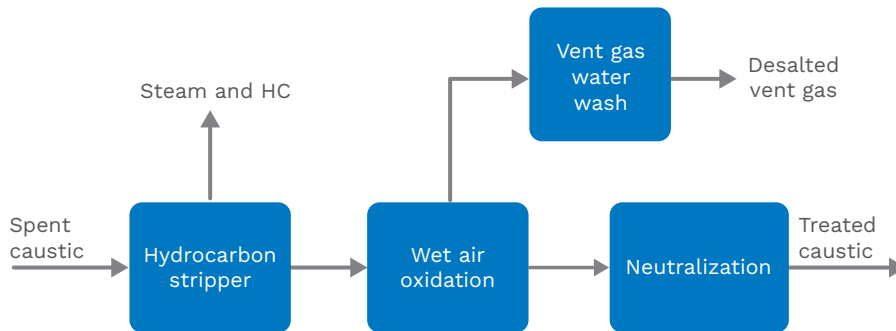

**Technip Energies uses a proprietary medium pressure (MP) Wet Air Oxidation (WAO) reaction to treat spent caustic effluent. The WAO system can be used to process suitable spent caustic produced from ethylene and other petrochemical units.** The technology provides a competitive balance between Total Installed Cost (TIC) and operating costs, while operating at an intrinsically safer lower pressure and temperature compared to alternate high-pressure technologies. The installed hydrocarbon stripper can remove nearly all light organic COD/BOD from the treated spent caustic.

- Intrinsically safer than high pressure technologies
- Use of lower cost alloys compared to other technologies
- The hydrocarbon stripper removes the organic COD/BOD from the spent caustic

## Application

- Ethylene Crackers / Other Petrochemical Plants

## Technology ownership

- Proprietary Technip Energies technology

## References

- 16 SCTU units are in operation globally, with another 5 in design or construction.

## Contacts

Tim Cook  
Process Technology Manager  
tim.cook@ten.com

Joel Guillaume  
Director Technology  
joel.guillaume@ten.com



## Application

Bring additional value to Ethylene producers' Historian data via a Cloud Service of Technip Energies named SAM<sup>®</sup>. The added value will be based on the IP and knowhow, tools of Technip Energies originating from being a licensor and EPC contractor. Our Partner Arundo will provide Cloud Computation, AI and ML capabilities.

## Technology Ownership

- Ethylene know-how owned by Technip Energies
- Cloud Software, Artificial Intelligence and Machine learning by Arundo.
- SAM<sup>®</sup> is fully owned by Technip Energies

## References

Clients in Europe

## Contact

Marco van Goethem  
Department Manager Pyrotec  
marco.vangoethem@ten.com



# SPYRO<sup>®</sup> for Asset Management (SAM<sup>®</sup>)

Powered by

ARUNDO

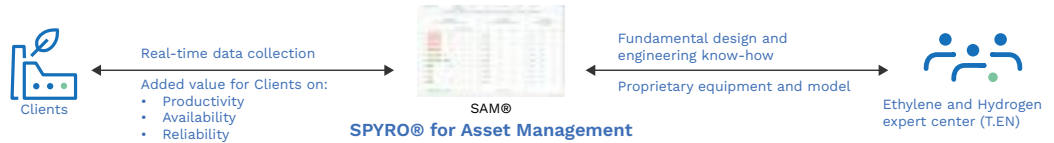

**SAM<sup>®</sup> is a new digital service of Technip Energies to improve the Operation, Availability and Reliability of ethylene plants.** This service enhances the optimization and simulation capabilities of SPYRO<sup>®</sup> by leveraging the expertise of Arundo, a provider of proprietary software and advanced analytics solutions for asset-intensive industries in the Machine Learning and cloud computing space. SAM<sup>®</sup> provides the plant's personnel with operational key performance indicators, alerts issues and continuously suggests optimization opportunities based on real time plant data. SAM uses Technip

Energies proprietary SPYRO<sup>®</sup> software for prediction and optimization of the plant and applies the key know-how required to design these plants.

SAM aims to unlock the hidden information in the historical data of an ethylene plant by application of Technip Energies know-how and experience as a licensor and as an EPC contractor. Technip Energies differentiates from the existing players in the optimization field by our fundamental design and engineering knowledge on ethylene plants, proprietary equipment and models such as SPYRO<sup>®</sup>.



# SPYRO®<sup>®</sup>, The Steam Cracking Simulation Standard

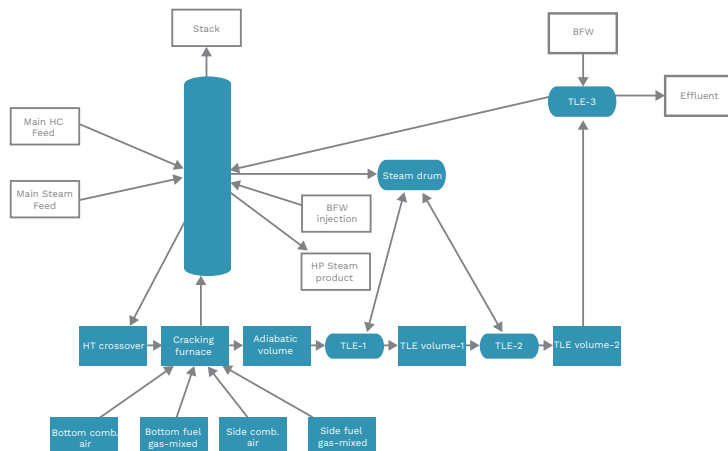

**SPYRO® 8 is a program for the design, simulation and optimization of the steam cracking furnaces. SPYRO® 8 allows accurate prediction of yields for feedstocks ranging from gases to gas oils at any operating conditions. SPYRO® 8 enables Technip Energies to execute EPC projects, where guarantees provided are amongst others based on SPYRO. SPYRO is used by the majority of the Ethylene producers.**

The software can simulate any type (Technip Energies and non-Technip Energies) of steam cracking furnace in commercial use today. The furnace geometries are configured by our Pyrotec engineers for each SPYRO application for an Ethylene Producer.

Next to the desktop version of SPYRO® 8, there is also an Integrated version available that can

be integrated in Advanced Process Control, Real Time Optimization and Planning and Scheduling software of third parties, such as amongst others AspenTech, Aveva, Honeywell, etc.

The SPYRO® 8 (Full Furnace Simulation) license is delivered to simulate all types of furnaces present on the Application Site.

A coke deposition model in SPYRO® 8 allows users to estimate the run length of the furnace.

SPYRO® 8 has a dedicated graphical user interface (GUI). Through the flowsheet-oriented approach of the program, the user keeps a clear overview of the models present in the case and their interconnectivity in an intuitive manner.

## Application

Technip Energies uses SPYRO® as the key instrument in designing its ethylene furnaces. Our PYROTEC department licenses the SPYRO software to petrochemical companies for rigorous simulation of their cracking furnaces. The software is provided as a desktop application and offers integrated versions for the application in advanced process control, real time optimization and planning and scheduling software.

## Technology ownership

- Proprietary Technip Energies technology

## References

- The majority of the Ethylene producers are using SPYRO in their day to day operations.

## Contacts

Aksel Aksam  
VP Business Development & Sales  
aksel.aksam@ten.com

Eric Wagner  
Director Technology  
eric.wagner@ten.com



SPYRO® 8 gives users the possibility to simulate:

- Full furnace (radiant coil, firebox, convection section, TLE, steam drum, adiabatic volume)
- Multiple furnaces in one model (with possibility to mix the effluents)
- Multiple furnaces in one model including recycle streams
- Co-cracking (mixing feed stocks upstream the radiant coil)
- Hybrid cracking (different feed stocks in separate coils within one furnace)

Typical tasks performed with SPYRO® 8 are, among the others:

- Optimization of operating modes of the furnaces
- Evaluation of feed profitability, optimization of feed ratios
- Case studies, evaluation of furnace operations
- Building extended models of the ethylene plant
- Process design of furnaces

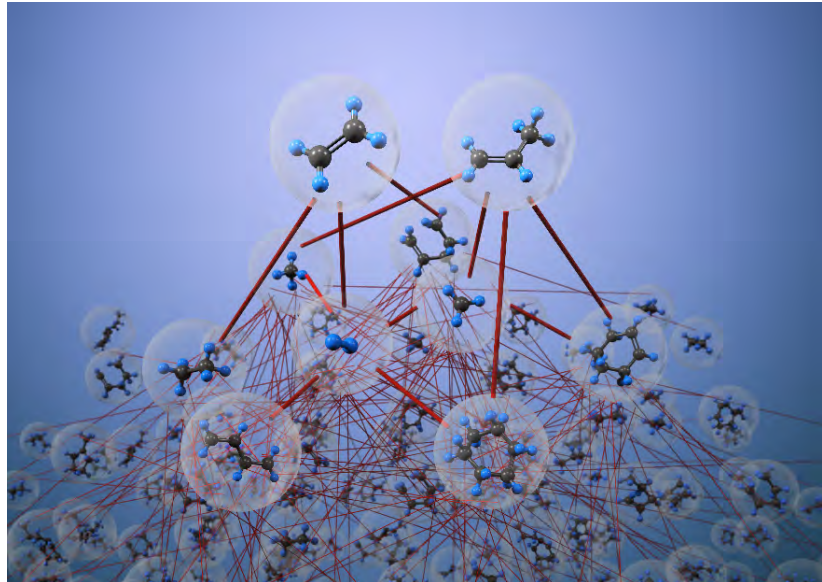

# Steam cracking furnaces and product recovery (gaseous feedstocks)

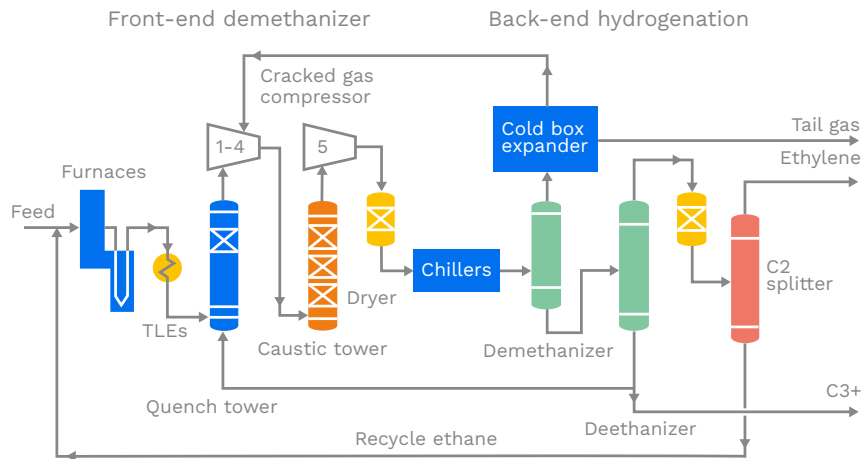

The technology is based on either legacy Stone & Webster or legacy Technip technology, using pyrolysis of ethane followed by progressive separation. This allows processing of hydrocarbons at low energy consumption, with a particularly low environmental impact. This concept is applied either for front-end hydrogenation or back-end hydrogenation:

- Front-end hydrogenation corresponds to a front-end deethanizer, where the hydrogenation reactor is placed at the deethanizer overhead, or to a front-end depropanizer, where the hydrogenation reactor is placed at the depropanizer overhead.
- Back-end hydrogenation corresponds to a front-end demethanizer, where the hydrogenation reactor is placed at the tail-end C2 cut.

Ethane is preheated to recover heat and then cracked by combining with steam in a tubular pyrolysis furnace at an outlet ranging between 815°C and 870°C. The furnace technology can be either SMK coils or USC@-M or USC@-W coils. Residence time in the pyrolysis section ranges from 0.3 seconds to 0.5 seconds. This design approach allows long run length (more than 60 days), mechanical integrity and attractive economics.

The hydrocarbon mixture at the furnace outlet is quenched rapidly in the primary linear exchangers (USXs) or transfer line exchangers (TLEs), generating very-high-pressure steam. Further heat recovery takes place in secondary and tertiary quench exchangers. The cracked gas flows to a quench water tower for

## Application

To produce polymer-grade ethylene by steam cracking of ethane (or in mixture with propane), pyrolysis in cracking furnaces, followed by progressive separation, is used to minimize energy consumption

Key features include:

- Cracking of liquid feeds in either USC@ or GK series proprietary Technip Energies furnaces.
- Optional front-end or back-end C2 hydrogenation system.
- Enhanced reliability through use of low-fouling/high-capacity Ripple Trays.

## Technology ownership

- Proprietary Technip Energies technology

## References

- Since 2000, the technology has been selected for 21 ethylene plants which use ethane as feedstock, representing more than 25 metric MMtpy of ethylene.
- 15 of the 21 plants are based on very large capacities (1 metric MMtpy or more) — in particular, the largest currently operating ethylene plant, with a capacity of 2 metric MMtpy of ethylene; and the largest mixed feed cracker (naphtha/LPG/ethane) ever built, with capacity of 1.5 metric MMtpy of ethylene.

## Contact

Jim Middleton  
Ethylene Product Line Leader  
jim.middleton@ten.com



water recovery and removal of tars. The gas is then compressed to approximately 30 bar(g) and dried for further chilling. A caustic scrubber is placed at the compressor interstage to remove acid gases.

After chilling, a simple demethanizer at medium pressure allows removal of methane and recovery of the C2 cut. The bottoms from the demethanizer are sent to the C2 cut treatment for ethylene purification.

The C2 splitter operates as an open heat pump. The tower can be arranged as an open heat pump integrated with the ethylene refrigerant for front-end hydrogenation, or as a closed heat pump with propylene refrigerant for the back-end hydrogenation scheme. The recovered polymer-grade ethylene is sent either to downstream units or to storage.

The recovered ethane from the C2 splitter is recycled to furnaces for further cracking.

Cracking a mixed ethane/propane feed, or cracking of a large amount of ethylene feed, allows for production of polymer-grade propylene from a C3 splitter. The residual propane is recycled to furnaces for cracking. The recovered C4s and light gasoline are recovered in the debutanizer and exported with or without treatment.

Gas expansion (heat recovery) and external cascade using ethylene and propylene (or propane) systems supply the required refrigeration to achieve at least 99.6% ethylene recovery.





# Steam cracking furnaces and product recovery (liquid feedstocks)

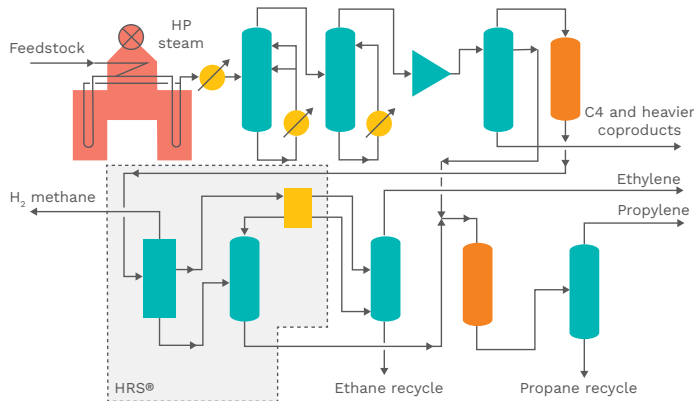

**Fresh feed and recovered recycle streams are sent to the cracking furnaces.** Cracking will occur at temperatures and resident time requirements specific to the feedstock and product requirements. We offer several furnace radiant coil designs which are optimized for different feeds and run lengths between decokes. For cracking liquid feeds the optimum coils are normally the USC®-U and GK® type low residence coils.

Olefin yield is preserved using rapid quenching, which simultaneously produces high-pressure steam, while lower-temperature heat is recovered for generation of dilution steam. Pyrolysis fuel oil and gasoline byproducts are recovered in the quench oil and quench water systems. Cracked gas is compressed and treated with caustic to remove acid gases, and then dried prior to fractionation.

The low-fouling, dual-pressure depropanizer is used for front-end C2 hydrogenation schemes, where C3 and lighter components are separated from C4 and heavier components before acetylenes are hydrogenated in the acetylene hydrogenation reactor. The stream is then routed to the demethanizer chilling section, where methane and lighter components are separated from C2 and heavier components, using either Heat Integrated Rectification System (HRS®) or our patented cold section approach. To achieve greater energy efficiency and hydrogen recovery, a turboexpander is used in the demethanizer system. The proprietary chilling section design minimizes refrigeration energy, lowering both capital and operating cost.

## Application

Producing polymer-grade ethylene, propylene and other valuable co-products by thermally cracking liquid feedstocks and efficiently purifying the products using state-of-the-art recovery systems. Key features include:

- Cracking of liquid feeds in either USC® or GK series proprietary Technip Energies furnaces.
- Optional front-end or back-end C2 hydrogenation system.
- Efficient recovery of olefins via a heat-integrated rectifier system (HRS).
- Enhanced reliability through use of low-fouling/high-capacity Ripple Trays.

## Technology Ownership

- Proprietary Technip Energies technology

## References

- Since 2000, the technology has been selected for 23 grassroots facilities based on liquid feedstocks and representing more than 21 metric MMtpy of ethylene.
- Eight of the 23 plants are based on a very large capacity of > 1 metric MMtpy of ethylene
- The largest mixed-feed cracker (naphtha/LPG/ethane) ever built, with capacities of 1.5 metric MMtpy of ethylene and 0.5 metric MMtpy of propylene.
- References include heavy hydrocarbons cracking, such as vacuum gas oil with EBP over 500°C.

## Contacts

Jim Middleton

Ethylene Product Line Leader

[jim.middleton@ten.com](mailto:jim.middleton@ten.com)



Ethylene is purified in the low-pressure C2 splitter heat pump, which fractionates ethylene from ethane in a highly efficient manner. The C2 overhead stream is routed directly to the integral C2 refrigeration system, where polymer-grade ethylene is withdrawn. C3s from the dual-pressure depropanizer system are combined and optionally further hydrogenated before being directed to the propylene-propane fractionator. C4 and heavier coproducts are further separated in a sequence of distillation steps.

## Advantages

- Unique experience in the recent design of large capacity ( $\geq 1000$  kTA) liquid cracking plants.
- High energy efficiency plant designs.
- Our plants have fast start-up times, can operate for a long time between turnarounds and are reliable in operation.



# Swirl Flow Tube® (SFT®) Furnace Radiant Coils



Process Engineering  
Mechanical Engineering  
Estimating/Procurement  
Project Execution



SFT Manufacturing



Procure straight tube  
Bending SFT coils  
Assembling SFT



The SFT® is a helical tube which enhances the heat transfer by a more intense mixing in the circumference compared to the classical straight tubes and gives Technip Energies a significant technological advantage over its competitors. It is more than a decade that Technip Energies acquired a new technology called the SFT® (Swirl Flow Tube®) for optimizing cracking furnaces. Over this period, Technip Energies has developed own bending technology and tooling to fabricate the SFT®.

## Swirl Flow Tube® advantages

- High performance radiant tube
  - Longer run time
  - Possibility to increase the yield
  - Increased capacity or lower emissions
- In operation since May 2017
- Excellent performance in the field
- Suitable for all radiant coil materials
- Handles both gaseous and liquid feedstock

## Application

- Technip Energies optimizes its steam cracking furnaces and maximizes the ethylene yield with the SFT® (Swirl Flow Tubes®)

## Technology Ownership

- Proprietary Technip Energies technology

## References

- Clients in Europe and Middle East

## Contact

Jelle-Gerard Wijnja  
Technology Manager Ethylene Furnaces  
jelle-gerard.wijnja@ten.com







# Biochemicals



## Application

Succinic acid is a precursor, as a replacement of maleic anhydride (MAN), for the production of Butanediol (BDO) which is used as a solvent or in various polymer applications. It can also be used for biopolymer production such as polybutylene succinate (PBS).

Additionally, succinic acid can be used as basis of certain biodegradable polymers and as component of some specific resins. Succinic acid also has application in the food, dietary supplement and pharma industries.

## Technology Ownership

Originally developed by Reverdia, a joint venture between Royal DSM and Roquette Freres, BioSA technology is fully owned by Technip Energies since July 2022.

## References

- Roquette (Italy) – 10 kta
- LCY Bioscience (Canada) – 30 kta

## Contact

Emilien Mathiot  
Licensing Manager  
emilien.mathiot@ten.com



# BioSA – Biosuccinum®

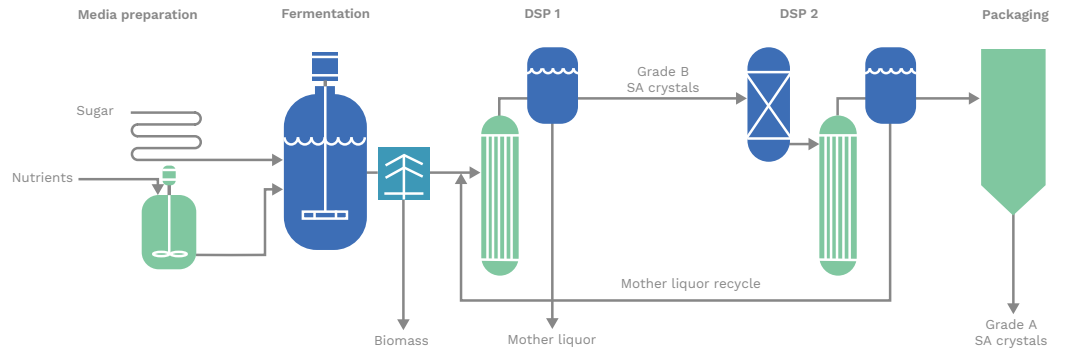

**BioSA is obtained by fermenting first generation sugar feedstock, including wheat, corn, sugar beet or sugar cane, with a proprietary strain of GMO yeast.** Polymer grade ('grade A') succinic acid is produced as crystals with two train of downstream processing applying classic bioprocess unit operations such as ion exchange, evaporation and crystallization.



# Brine purification (Pure.rBrine)

Pure.rBrine™  
by T.EN

Pure.rBrine™ by T.EN integration into a glycerine and caustic based epichlorohydrin with recycling to cells:

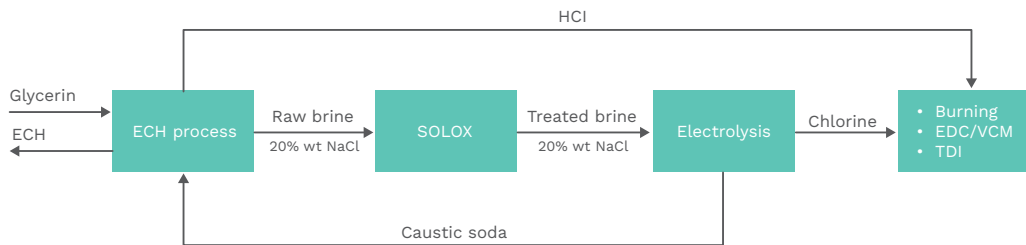

The Pure.rBrine treatment is an oxidative chemical-thermal treatment, in which the dissolved organic substances in the brine effluent are oxidized to carbon dioxide and water. It is a wet oxidation treatment because the oxidation proceeds in the aqueous phase. The oxidation reagent is a mixture of chlorine, hypochlorous acid and hypochlorite ions where the proportion of the species is fixed by the pH, the salinity and the temperature of the liquid reaction mixture during the treatment. Pure.rBrine mainly composes of four parts: The reaction in basic solution with sodium hypochlorite, the reaction in acid solution with hypochlorous acid, the neutralization of chlorine excess in brine and vent gas absorption.



## Application

- Pure.rBrine is a technology for the treatment of brines containing dissolved organics for recycling to electrolysis cells or disposal.
- Oxidative chemical-thermal treatment which transforms organics into CO<sub>2</sub> and water, with applications in the field of Epichlorohydrin, Epoxy resin, Propylene Oxide, EDC/VCM

## Technology ownership

- Proprietary Technip Energies technology

## References

- Brine from propylene and lime based epichlorohydrin, 1992 (Germany)
- Brine from propylene and caustic based epichlorohydrin, 2000 (Germany)
- Brine from glycerin based epichlorohydrin, 2012 (Thailand)
- Brine from EDC/VCM, 2014 (Russia)
- Brine from glycerin based epichlorohydrin, 2024 (SK)
- Brine from glycerin based epichlorohydrin, 2024 (India)

## Contact

Marc Manyeres  
Licensing Manager  
marc.manyeres@ten.com





## Application

- Epichlorohydrin (ECH) is an intermediate for epoxy resins production with various applications such as coatings, composites and adhesives.
- High purity ECH is produced by Epicerol® technology from glycerol, hydrochloric acid and caustic soda feedstocks.
- Epicerol® also includes Pure.rBrince by T.EN technology for treating the brine byproducts, allowing for its disposal or recycling to electrolytic cells.
- Epicerol® also allows for Low-CAPEX capacity increase of propylene-based plants by introduction of a parallel glycerol-to-DCPol synthesis and with very limited modification to the downstream ECH plant sections.

## Technology ownership

- Proprietary Technip Energies technology

## References

- 100 kta Epicerol® plant, Thailand (S/U 2012)
- 20 kta glycerol hydrochlorination section integrated into a propylene-based plant, France (S/U 2007)
- 50 kta Epicerol® plant, India (S/U 2022)
- 100 kta Epicerol® plant, SK (S/U 2024)
- 50 kta Epicerol® plant, India (S/U 2024)

## Contacts

Marc Manyeres  
Licensing Manager  
marc.manyeres@ten.com



# Epichlorohydrin (Epicerol®)

**EPICEROL®**  
SUSTAINABILITY BEGINS AT THE SOURCE

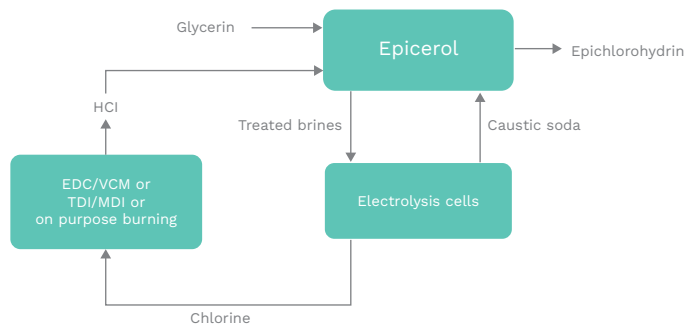

**Dichloropropanol (DCPol) is produced by reacting glycerol and gaseous HCl using an organic catalyst. DCPol is further reacting with caustic soda in a dehydrochlorination reactor.** The produced biphasic liquid is separated into an organic phase including raw ECH and a brine solution. The raw ECH is further purified through distillation where unreacted DCPol is recovered, and high purity ECH is produced. The brine is stripped to reduce the dissolved organics and further purified in the Pure.rBrince treatment section.

## Advantages

- Uses renewable versus fossil fuel raw materials
- Produces less CO<sub>2</sub> emissions and water effluents
- Creates fewer chlorinated by-products
- Consumes less water, chlorine and steam
- Operates at a lower temperature and pressure
- Lower CAPEX due to one process step less



# Ethanol to Ethylene (Hummingbird®)

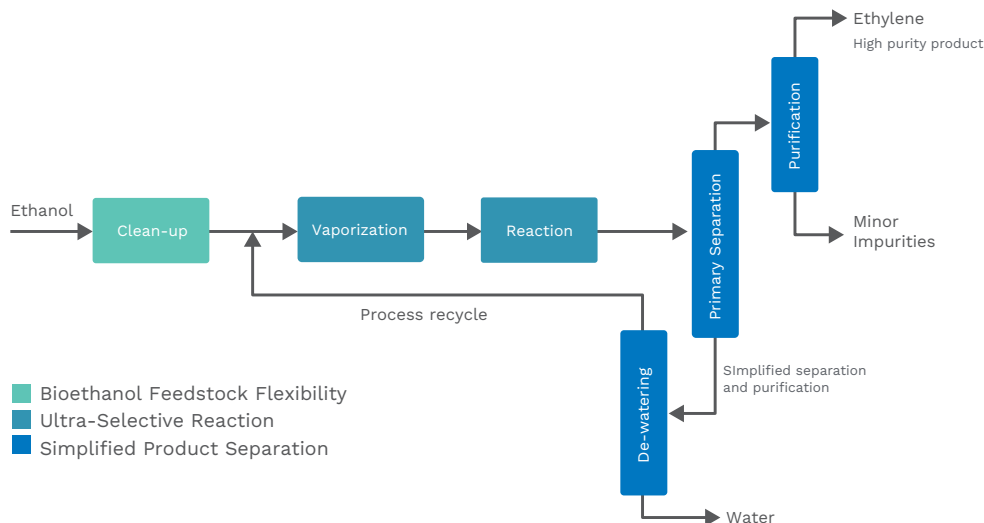

**A simple low-cost process for dehydrating ethanol to ethylene, operating at a lower temperature and higher pressure than first generation alumina based catalyst Ethanol to Ethylene processes using a proprietary Heteropoly Acid Catalyst.** Designed to process hydrous or anhydrous fuel grade ethanol, it produces polymer grade ethylene with a selectivity of over 99%.

## Application

- Drop-in technology for the ethylene value chain, providing on demand production capacity. Suitable for renewable generation into existing infrastructure or for bespoke generation remote from existing ethylene capacity.

## Technology ownership

- Proprietary Technip Energies technology and catalyst ownership

## References

- 1st License Design under development in the USA. Fully scalable, with enquiries received ranging from 5 to 370 kta ethylene production.

## Contacts

Erik Moy  
Licensing Manager  
erik.moy@ten.com

Andrew Simpson  
Technologist – Green Chemicals  
andrew-martin.simpson@ten.com



## Application

- Biodegradable polymers according to EN 13432
- Suitable for applications such as packaging and films e.g. in agriculture

## Technology ownership

- Proprietary Technip Energies technology

## References

- China, Start up 2019, 180 tpd
- In total 6 licenses sold

## Contact

Stefan Deiss  
Head of Product Management and R&D  
stefan.deiss@ten.com



Zimmer® Polymer Technologies

# Polybutylene adipate terephthalate (PBAT) and Polybutylene succinate (PBS)

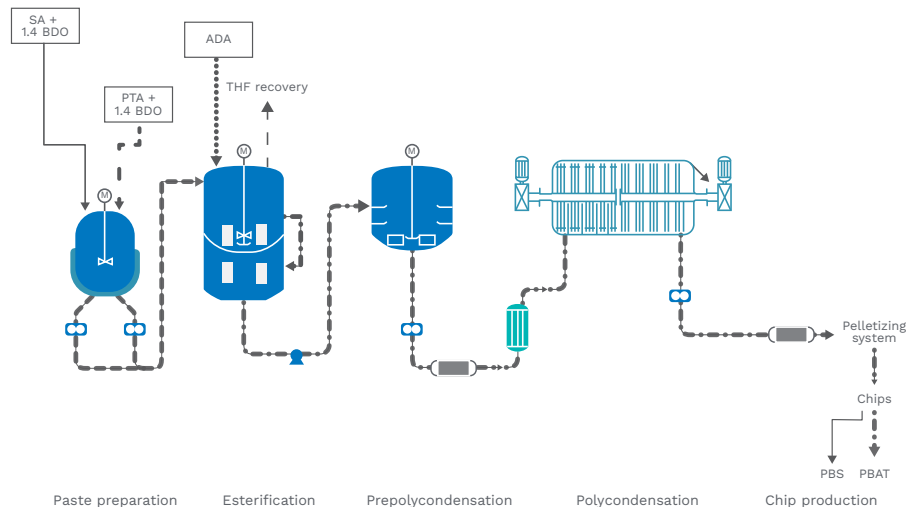

**In the continuously operated PBAT process, the raw materials purified terephthalic acid (PTA), 1,4-butane diol (BDO) and adipic acid (ADA) react in two separate consecutive esterification steps.** Through consecutive steps, polycondensation takes place with formation of PBAT under vacuum in Zimmer®'s proprietary Double Drive Reactor (DDR). For production of PBS, succinic acid is used as a raw material instead of PTA. It can therefore be produced from bio-based sources.

## Advantages

- Special plant setup allowing flexible production of all three polymers (PBT, PBAT, PBS) depending on the requirements of the market
- High and controlled viscosities in DDR

# Polylactic acid (PLAnet™)

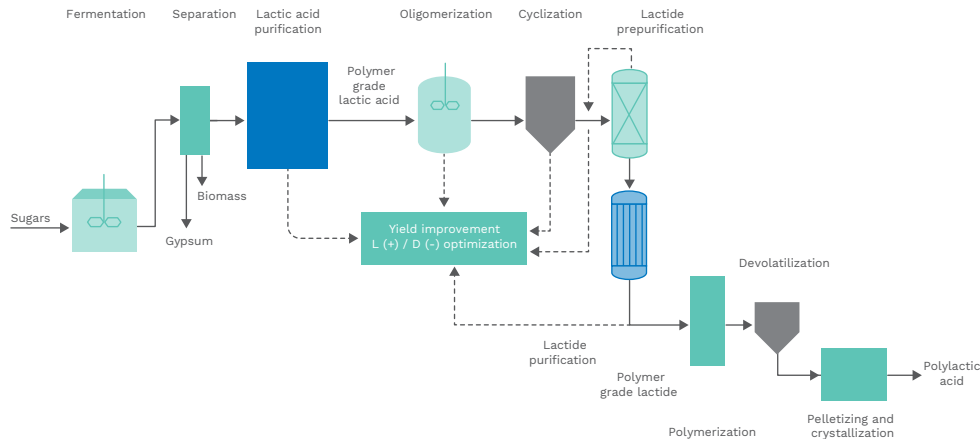

**Lactic acid (LA) is produced by fermentation of sugars and then purified by centrifugation, filtration and evaporation to obtain polymer grade LA.** Pure LA is first transformed into lactide (cyclic dimer of LA) before being polymerized to PLA.

PLAnet™ technology also includes a process residue recycling unit (to polymer grade LA) and a distillation unit allowing to finetune the content of the D-isomer in the final product.

## Advantages

- Feedstock flexibility
- High yield fermentation process
- Food grade and non-GMO PLA products
- Variety of PLA grades and applications
- PLA waste recycling back to virgin lactic acid with LOOPLA technology
- Fast and easy transition between PLA grades

## Application

- Versatile, bio-based and biodegradable polymer that replaces petroleum-based plastics in a wide range of applications.
- Used in applications such as thermoforming, fibers and non-wovens, film, injection molding, bottles, rotomolding and 3D printing.
- Provides the plastic industry with new opportunities to meet challenging product specifications and market demands.

## Technology ownership

- Proprietary Technip Energies technology with Sulzer

## References

- 20 kta lactic acid from beet sugar (start-up 1992 – revamped 2008)
- 50 kta lactic acid from corn glucose (start-up 2004)
- 80 kta lactic acid + 30 kta PLA from corn glucose (under construction)
- 10 kta PLA from lactide (start-up 2015)
- 75 kta PLA from lactide (start-up 2018)

## Contact

Alessandra Adriatico  
Licensing Manager  
alessandra.adriatico@ten.com







# Fertilizers



## Application

- Ammonia is a key intermediate for fertilizers such as Urea, Ammonium Nitrate/Phosphate and NPK compounds as well as a variety of industrial applications (e.g. Urea-based synthetic resins, Polyurethanes and Refrigerants).
- Globally, more than 90% of ammonia production is consumed in fertilizers industry and more than 50% in urea production.

## Technology ownership

- Proprietary Haldor Topsoe (HTAS) Technology
- Technip Energies Club Contractor (exclusive alliance towards HTAS through a General Agreement also covering Methanol co-production with common front-end syngas production based on SynCOR™ technology)

## References

19 references in Ammonia projects (FS, BED, FEED and EPC) in the last 15 years with capacities ranging from 1,000 MTPD to 3,300 MTPD

## Contact

Jérémie Esquier  
Technology & Consulting  
Director, Fertilizers  
jeremie.esquier@ten.com  
topsoe.com



# Ammonia

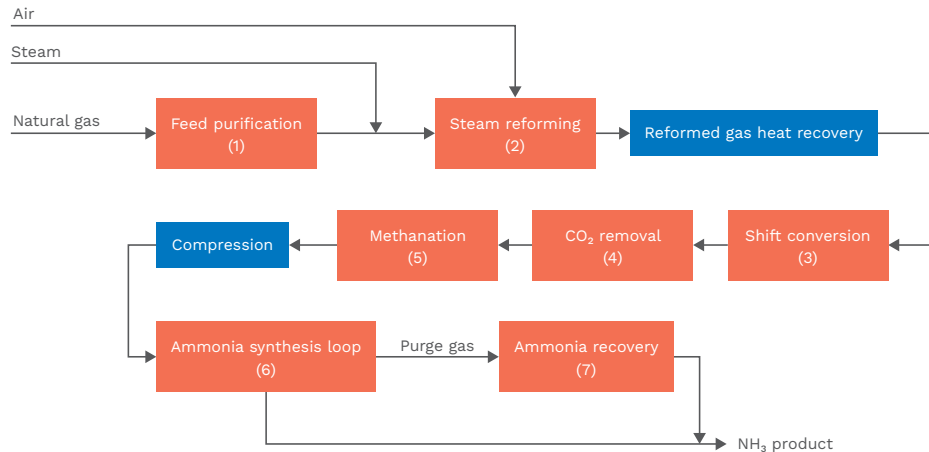

## The Topsoe low energy ammonia process includes different sections:

1. Removal of sulphur compounds from the feed gas to avoid poisoning of catalysts.
2. Stepwise conversion into synthesis gas (a mixture of  $H_2$ , CO and  $CO_2$ ) by catalytic reforming with steam, in: a side fired primary reformer; a catalytic secondary reformer with atmospheric air and, optionally, a heat exchanger reformer (HTER) operating in parallel with the above-mentioned reformers.
3. Shift conversion: CO is converted into  $CO_2$  and  $H_2$  by reaction with steam.
- 4.&5.  $CO_2$  absorption followed by removal of residual CO and  $CO_2$  by methanation reaction with  $H_2$  (reverse reforming).
6. Compression and feeding to the ammonia synthesis section, normally having a single radial flow converter but can, alternatively be based on two radial flow converters operating in series, in case very low energy consumption is required. Downstream cooling down to a suitable temperature for ammonia product condensation.
7. Purge gas feeding to the ammonia recovery section for ammonia product recovery.



**Advantages:**

- Low energy consumption
- Low emissions

SYNCOR Ammonia™ plant concept is the new generation of ammonia plants based on an autothermal reformer (single step reforming with oxygen instead of air) offering significant benefits in large scale applications (potential single-train capacities exceeding 6,000 MTPD).



PetroVietnam Fertilizer and Chemicals Corporation, Phyl My, Vietnam

## Application

- Over 80% of the production of phosphoric acid in the world used as intermediate product to produce single nutrients and multi-component fertilizers.
- Other applications mainly in metallurgical industry (surface treatment) and food industry.

## Technology ownership

- Proprietary Technip Energies technology. Includes proprietary UCEGO® vacuum table filter.

## References

- More than 70 reaction and filtration units installed in 28 different countries,
- More than 90 UCEGO® filters manufactured and installed.
- More than 90 concentration units, with capacity up to 1,100 tpd evaporated in a single line.
- Extensive references for R&D laboratory test works including 570 phosphate rocks in reference and over 1,300 laboratory pilot tests made in Technip Energies laboratory pilot testing facility.

# Phosphoric acid DH process

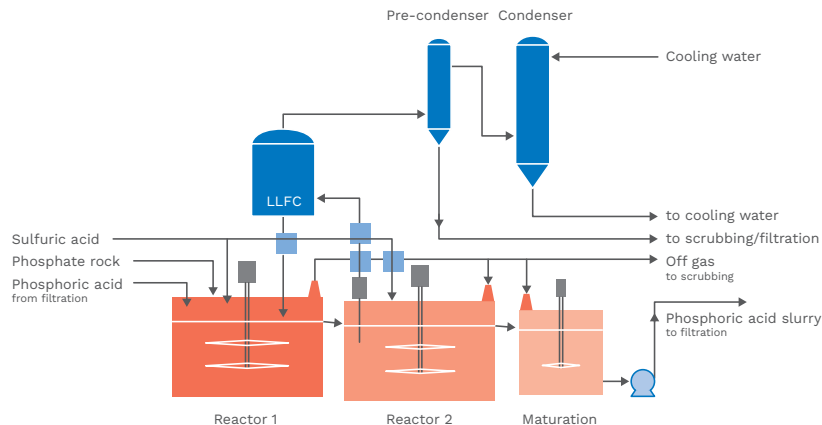

**Initially invented in 1953 by French company St Gobain, and continuously developed by Rhône-Poulenc through four decades,** the Technip Energies phosphoric acid DH process was acquired by Technip Energies in 1992 and further developed since that time.

Starting from the initial single tank reactor concept Technip Energies propose today 3 variations of the DH technology for reaction:

- **SINGLE REACTOR** Process: the historical process, with a single large reactor,
- **DIPLO** process: with 2 reactors in series, enables optimizing reaction/ filtration performance, for highest  $P_2O_5$  recovery
- **LCFC** (Large Capacity Flash Cooled reaction system): specifically designed for large capacity units with flash cooling and maturation

Main features for Technip Energies process:

- Di-Hydrate route
- Non-compartmented large reactors
- High efficiency/High flow single central reactor agitator
- Efficient air-cooling and flash cooling technologies for reaction cooling
- UCEGO® table filter for the separation of phosphogypsum and acid
- High performance scrubbing system
- High velocity heat exchangers for acid concentration
- High performance Fluosilicic acid Recovery Unit (FRU) at concentration
- Simple and economic vacuum system for concentration unit

### Circular Economy and environmental impact

Enhanced reaction recovery offered by the High Recovery Diplo process allows to produce purer gypsum for maximum reuse and valorisation into industrial applications such as cement or plaster.

The units proposed by Technip Energies are designed to meet the most stringent environmental standards, with zero liquid effluent.

Technip Energies operates its own phosphate laboratory pilot testing facility to support its clients for assistance to production and projects, design of new units and development of specific process solutions.

### Advantages

- Ease of operation
- High operating factor
- Low operating cost
- Low maintenance cost
- Low energy consumption
- Flexible process for various phosphates
- Zero liquid effluent

### Contact

Philippe Malsan  
Product Technology Manager  
philippe.malsan@ten.com



Large capacity concentration units (1,100 tpd evaporated), MOSAIC Brazil, Uberaba, Minas Gerais, Brazil



UCEGO® filter 12A (239 m<sup>2</sup>)



FOSFERTIL, Uberaba, Brazil. Phosphoric acid unit: 1,020 tpd

## Application

- First synthesized chemical in tonnage in the world.
- More than 70% of the worldwide production dedicated to the fertilizer industry,
- Other application in metallurgical, steel chemical and petrochemical industry, water treatment and pulp and paper industry

## Technology ownership

- MECS® sulfuric acid technology licensed by Elesent Clean Technologies

## References

- More than 150 Sulfuric acid plant references by Technip in 40 countries,
- Capacities ranging from 100 MTPD to 3,600 MTPD erected.

## Contact

Philippe Malsan  
Product Technology Manager  
philippe.malsan@ten.com



# Sulfuric acid production processes (MECS® sulfuric acid technology)

Typical MECS® sulfur burning plant flowsheet, including HRS™ system:

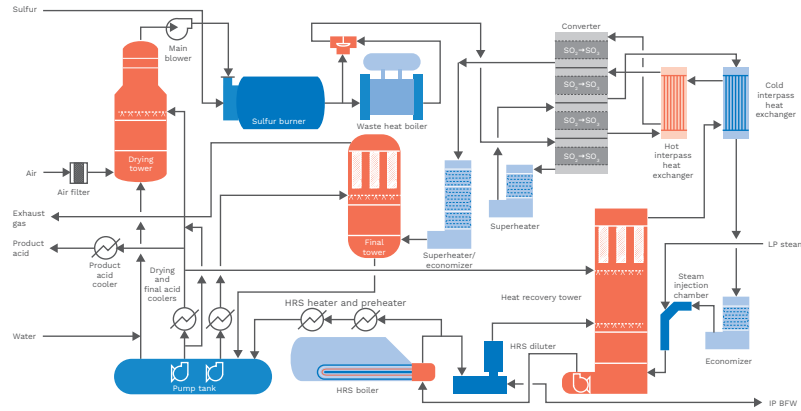

Typical MECS® metallurgical plant flowsheet:

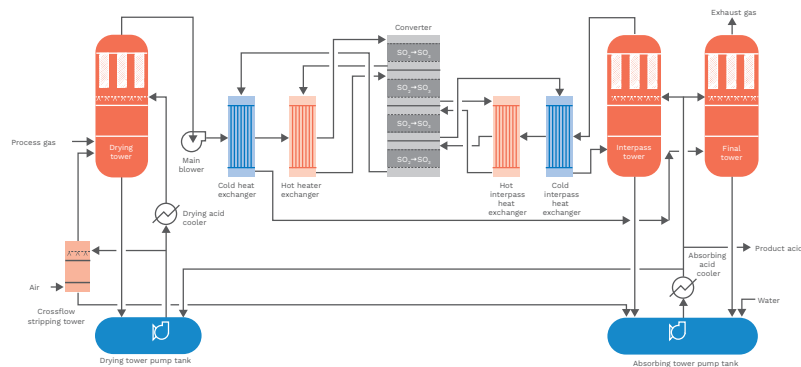

**Sulfuric acid production uses sulfur dioxide (SO<sub>2</sub>) as a feedstock. Depending on the type of plant, SO<sub>2</sub> can be from various sources such as sulfur burning, off gases from sulfidic ores roasting or smelting processes, spent acid decomposition.** Each sulfuric acid process is tailor-made for the application.

Sulfuric acid production means first SO<sub>2</sub> gas cooling, cleaning and conditioning as required. Then SO<sub>2</sub> is catalytically converted to sulfur trioxide (SO<sub>3</sub>), and finally SO<sub>3</sub> is absorbed into water, to produce sulfuric acid (H<sub>2</sub>SO<sub>4</sub>).

Technip Energies has an extensive experience in Sulfuric Acid, especially through the KREBS heritage dating back from the forties. KREBS originally worked with the PCUK technology and became a MECS® Sulfuric acid technology licensee in 1984.

MECS® Sulfuric acid technology provides best-in-class sulfuric acid plants and relies on a long reference list of more than 1,000 plants worldwide.

Technip Energies is member of MECS® Sulfuric acid technology club of licensees and has access to all Elessent Clean Technologies portfolio for sulfuric acid production including in particular:

- Sulphur Burning sulfuric acid process technology, with or without HRS™.
- Metallurgical sulfuric acid process technology

#### Advantages

- Robustness of the technology
- Meet most stringent environmental regulations
- High performances
- Quality and cost effective design
- High efficiency Heat Recovery System (HRS® by MECS® Sulfuric acid technology) with numerous track record references



3,600 tpd SA plant – TIFERT – La Skira, Tunisia

### Application

- Originally created in the early 60's
- Time-tested UCEGO® Filter designed to process phosphogypsum slurry for the industrial production of phosphoric acid

### Technology ownership

- Proprietary Technip Energies equipment exclusively manufactured by Andritz Separation

### References

Today, the UCEGO® Filter is used throughout the world, representing more than 90 filters sold in 28 countries

### Contact

Philippe Malsan  
Product Technology Manager  
philippe.malsan@ten.com



# Vacuum table filter (UCEGO®)



Example of Ucego® filter 12A

**The UCEGO® Filter is a vacuum filter consisting mainly of a patented extra flat rotating table made of stainless steel and supported by a rigid structure.** An independent endless rubber belt acts as the outer vertical edge of the table while the inner edge is an integral part of the table. The slurry is fed to the rotating table by a patented slurry feedbox, which insures perfect distribution. A uniform cake is formed on the table and the filtered phosphoric acid is collected in the troughs under the surface of the table. As the filtration is completed, the cake goes through two or three countercurrent wash sections to optimize the recovery of  $P_2O_5$ . The various filtrates are collected and drained separately in the central valve.

After washing and dewatering on the filter table the gypsum is discharged by endless screw and the table is washed and cleaned by sprayer rows before starting a new filtration cycle.

### Advantages

- High productivity - Low maintenance cost due to mechanical simplicity
- No dilution of the product acid
- Easy and fast access to the vacuum box
- High compacity of the design ( $m^2$  filtration area/ $m^2$  footprint)

### Standard Ucego® filters size

Filter No.	Active filtration area $z m^2*$	O.D. of table in m
1	9.0	4.20
2	15.0	5.30
3	23.7	6.40
4	35.2	7.65
5	41.4	8.25
6	53.3	9.95
7	65.1	10.80
8	88.1	12.30
9	112.1	14.20
10	135.7	15.40
11	157.6	17.10
11A	185.8	18.30
12	211.1	19.40
12A	236.3	21.0
13	263.9	21.30
14	320.0	23.10

\* Active filtration area is the same for both wet or dry discharge



# Sustainable Fuels







# Biofuels



## Application

- Fast pyrolysis bio-oil (FPBO) is a renewable, second-generation bioliquid that can be used as a sustainable alternative to fossil fuels to produce advanced biofuels, renewable energy and chemicals.
- FPBO technology transforms non-food, lignocellulosic biomass into a liquid.
- Easy to store and transport, and can be conveniently used in versatile applications including heat, power, transportation and in biorefineries.

## Technology ownership

- Proprietary, patented BTG Bioliquids technology
- Technip Energies exclusive provider of turnkey FPBO units including EPC

## References

- Empyro BV's pyrolysis oil production facility began operations in early 2015. The plant converts five tons of wood residues per hour into pyrolysis oil, process steam and electricity.

# BTG Bioliquids

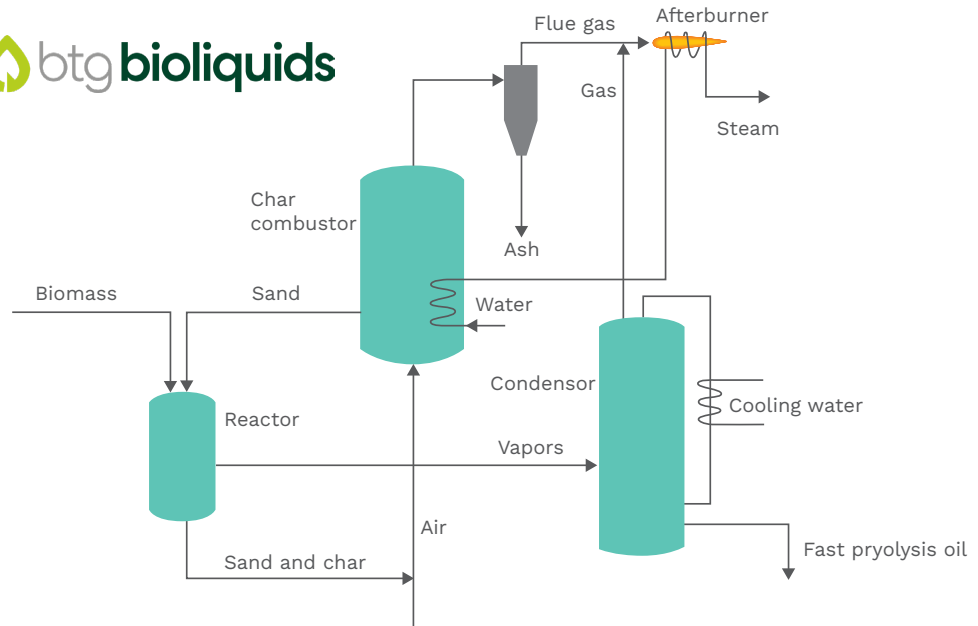

**Fast pyrolysis bio-oil (FPBO) is a second-generation bioliquid that can be used as a sustainable alternative to fossil fuels to produce advanced biofuels, renewable energy and chemicals.**

BTG's pyrolysis process is based on intensive mixing of small biomass particles with hot sand in a reactor without oxygen. The vapors leaving the reactor are

rapidly cooled in the condenser yielding in pyrolysis oil, char and gases. The gases and char are burned in the combustor to heat up the circulating sand. The surplus heat from the combustor is used to generate steam for power generation, biomass drying or external use. The minerals contained in the biomass stay behind in the ashes. They can be reused locally, avoiding mineral depletion.

### Advantages

- Alternative for fossil fuels for production of advanced biofuels, renewable energy and chemicals
- Processing (non-food) biomass waste streams
- Versatile applications for FPBO (heat, power, transportation fuels and bio-refineries)
- FPBO is easy to store and transport
- Reuse of remaining biomass minerals



Empyro BV, Hengelo, The Netherlands

### Plant data

- Capacity: 120 tons of dry biomass/day
- Up to 4,500 MWh gross power production
- Feedstock: wood residues
- Plant output per year:
  - 20 million liters oil
  - 80,000 tons steam
  - CO<sub>2</sub>- eq. reduction - 24,000 tons
  - ▶ Overall efficiency of 85% (biomass to pyrolysis oil and by-products of the process)

### Contact

Jacco Kroeze  
Sales Executive  
jacco.kroeze@ten.com



## Application

- The highest market share application for ethanol is alternative fuel or additive for gasoline blending.
- Another important market is the beverage industry, that requires highly concentrated and purified Extra Neutral Alcohol as raw material.
- At a minor scale are industrial, pharmaceutical and cosmetic applications.

## Technology ownership

- Proprietary Technip Energies technology for the core units: Hydrolysis, Fermentation, Distillation and Dehydration units.

## References

- More than 80 tailor-made plants since 1975.
- Standard capacities ranging from 15–800 m<sup>3</sup>/day.

## Contact

Claudia Coelho  
Ethanol Technologist  
claudia.coelho@ten.com



# Ethanol

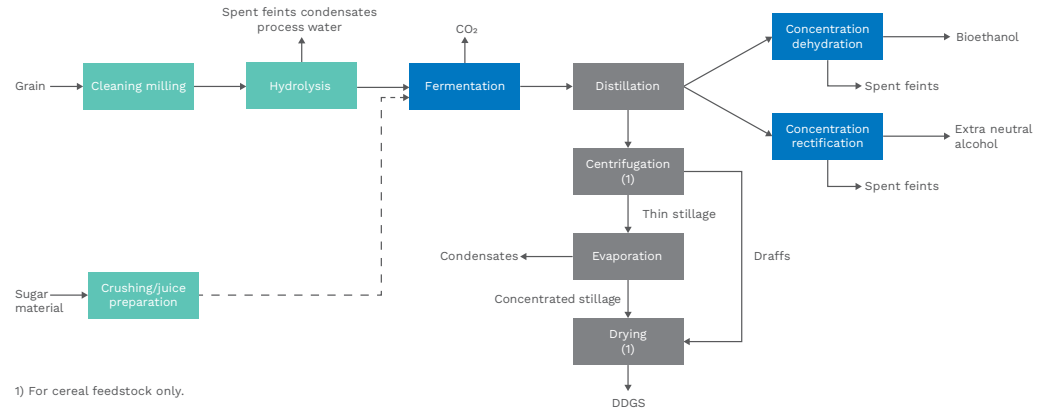

1) For cereal feedstock only.

Cereal grains are first cleaned and milled to obtain a flour with a good particle size for an easy downstream process. The starch contained in the flour is converted to fermentable sugars through enzymatic hydrolysis, at optimum temperature and pH conditions. The fermentable sugars are then converted to alcohol through an alcoholic fermentation by yeasts. The alcoholic mash is sent to the distillation and dehydration units for Bioethanol production or rectification unit for Extra Neutral Alcohol.

Depending on the feedstock and plant location, there is a range of processes available for the valorization of the side products. Thanks to our large experience, we can build tailor-made ethanol plants which are specifically configured to optimize product yields, side products valorization, heat integration, utilities consumption and effluents discharge.

## Advantages:

- Feedstock flexibility
- Tailor-made ethanol plants
- High heat integration plant with low steam consumption



Nedalco - Wheat Starch Slurry Distillery, France



# Refining



## Application

- Selective conversion of heavy feedstocks into petrochemical products into C3 – C4 olefins, in particular propylene; high-octane gasoline, aromatics.

## Technology ownership

- Technip ENERGIES in alliance with Axens, IFPEN and TotalEnergies

## References

- 127,000 BPSD unit in UAE

## Contact

Steve Shimoda  
Technology Department Manager  
steve.shimoda@ten.com

For information, email us  
at: fcc@ten.com



# Fluid Catalytic Cracking Resid to Propylene (R2P™)

**Based on the R2R™ resid fluid catalytic cracking (RFCC) process using a riser and a double regenerator for gasoline production, this new petrochemical version is designed for the production of light olefins, particularly propylene, and aromatics.**

The process is characterized by the utilization of two independent risers. The main riser cracks the resid feed under conditions to optimize fuels production; the second riser, PetroRiser™, is operated to selectively crack specific recycle streams to maximize propylene production.

The RFCC applies a short contact-time riser, proprietary injection system and severe cracking conditions for bottoms conversion. The temperature and catalyst circulation rates are higher than those used for a conventional gasoline mode operation. The main riser temperature profile can be optimized with a mixed temperature control (MTC) system.

Reaction products are then rapidly separated from the catalyst through a high-efficiency riser termination device (RS2™).

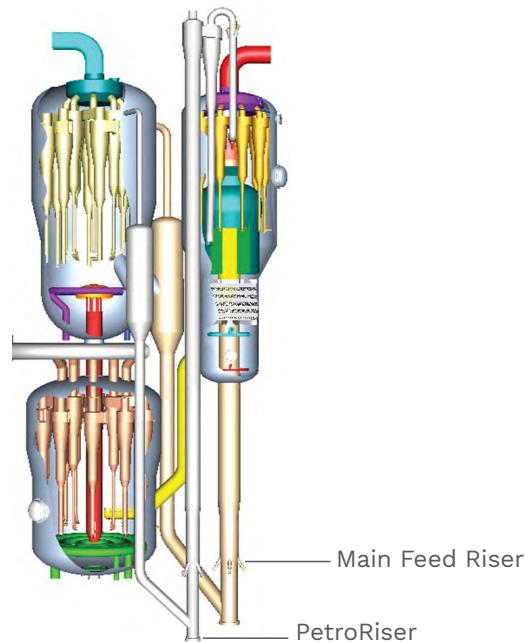

Recycle feed is re-cracked in the PetroRiser™ under conditions which are substantially more severe than in the main riser. A precise selection of recycle cuts combined with adapted commercial FCC catalysts and additives lead to high propylene yields with moderate dry-gas production.

The deactivated catalyst from both the main riser and PetroRiser™ are collected into a single packed stripper, which enhances steam stripping efficiency of the catalyst.

Catalyst regeneration is carried out in two, independent stages to minimize permanent hydrothermal activity loss. The first stage is operated in a mild partial-combustion mode that removes produced moisture and limits catalyst deactivation, while the second stage finishes the combustion at higher temperature to fully restore catalyst activity. The R2R™ system is able to process residue feed containing high metals and CCR using this regenerator configuration and even higher contents with the addition of a catalyst cooler.

The recycle feeds that are typically used in the PetroRiser™ are light and medium FCC gasoline as well as olefin streams coming from an oligomerization unit. This last option is of particular interest under market conditions that favor propylene over C4 olefins.

The reaction and regeneration sections use a cold-wall design that results in minimum capital investment and maximum mechanical reliability and safety. Units are tailored to fit the market needs (feedstock and product slate) and can include a wide range of turndown flexibility. Available options include power recovery, waste heat recovery, flue gas treatment, slurry filtration and light olefins recovery and purification.



## Application

- Selective conversion of gasoil and heavy residual feedstocks into high-octane gasoline and C3–C4 olefins.

## Technology ownership

- Saudi Aramco, ENEOS, King Fahd University of Petroleum and Minerals (KFUPM) with exclusive licensing rights belonging to Technip Energies and Axens

## References

- 76,000 BPSD unit in Ulsan, South Korea

## Contact

Steve Shimoda  
Technology Department Manager  
steve.shimoda@ten.com

For information, email us at: fcc@ten.com



# High Severity Fluid Catalytic Cracking (HS-FCC™)

The HS-FCC™ process is able to produce up to 25% propylene by converting heavy hydrocarbon feedstock under severe FCC conditions using a novel downflow reactor concept.

A 3,000 bpsd HS-FCC™ semi-commercial plant was operated at the ENEOS Mizushima refinery in Japan from 2011 to 2014. Alongside propylene, a considerable amount of butenes, gasoline and aromatics are produced as valuable byproducts. HS-FCC™ product portfolio can be increased towards propylene and aromatics by further downstream conversion of its less desired products, using proven technology approaches.

The main features of the HS-FCC™ process include a downflow reactor, high reaction temperature, short contact time reaction zone and high catalyst to oil ratio (C/O). Operating the HS-FCC™ process at high temperature and high C/O ratio results in two

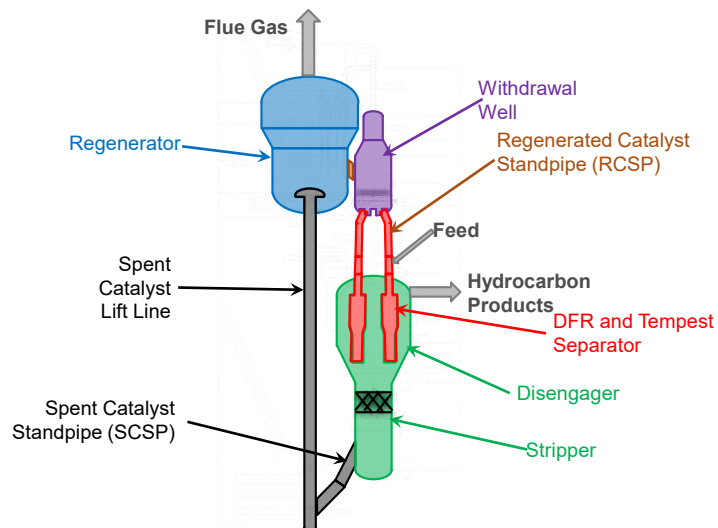

competing cracking reactions—thermal cracking and catalytic cracking. Thermal cracking contributes to dry gas production while catalytic cracking contributes to enhancing propylene yield of propylene.

A downflow reactor system has been adopted to balance these two cracking reactions. The catalyst and the feed flow downward along with gravity to minimize back mixing in the reactor and to obtain a narrower distribution of residence time that allows maximizing intermediate products such as gasoline and light olefins while minimizing dry

gas. The downflow reactor allows a higher C/O ratio because the lifting of catalyst by vaporized feed is not required. The downflow reaction ensures plug flow without back mixing.

The HS-FCC™ process is operated under considerably higher reaction temperatures (550°C to 650°C) than conventional FCC units. Under these reaction temperatures, however, thermal cracking of hydrocarbons also takes place concurrently with catalytic cracking, resulting in increased undesirable byproducts as dry gas and coke. Short contact time (around 0.5 sec) of feed and product hydrocarbons in the downflow reactor minimizes thermal cracking. Undesirable successive reactions such as hydrogen transfer, which consumes olefins, are suppressed.

To attain short residence time, the catalyst and products have to be separated immediately at the reactor outlet. For this purpose, a high-efficiency, short-residence time product separator, Tempest™, was developed and is capable of suppressing side reactions (oligomerization and hydrogenation of light olefins) along with coke formation.

To compensate a drop in conversion due to short contact time, the HS-FCC™ process is operated at high C/O ratio. Under the high C/O, there is the enhanced contribution of catalytic cracking over thermal cracking. High C/O maintains heat balance and helps minimize thermal cracking, over cracking and hydrogen transfer reactions.



3,000 BPSD semi-commercial unit in Mizushima, Japan

## Application

The Progressive Distillation Process minimizes the total energy consumption required to separate crude oils or condensates into hydrocarbon cuts. The product properties are optimized to fit with complex refining schemes. This process can be considered whether to topping units whether to integrated atmospheric and vacuum distillation units.

The concept can be applied to new units but is also particularly fit for revamps (capacity increase, lighter crude processing) with a view to optimize energy efficiency and minimize the modifications to existing assets and major equipment such as fractionator and furnace.

The process is particularly suitable when more than two naphtha cuts are to be produced, for example, in integrated refinery and petrochemical complexes. Typically the process is optimized to produce three naphtha cuts or more, one or two kerosene cuts, two atmospheric gas oil cuts, one vacuum gas oil cut, two vacuum distillates cuts, and one vacuum residue stream.

## Technology Ownership

- TotalEnergies and Technip Energies

# Progressive Distillation

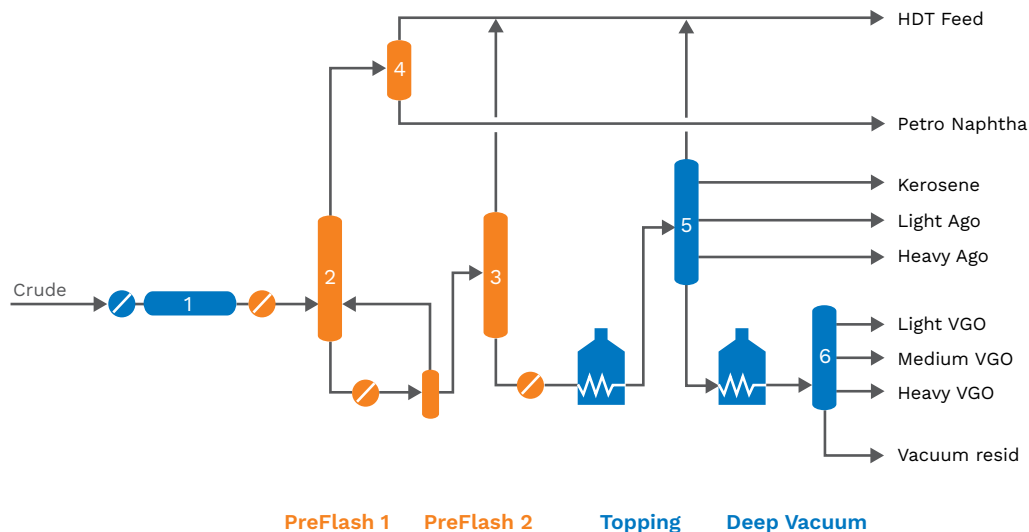

**The crude is preheated and desalted (1). It is fed to a first dry reboiled pre-flash tower (2) and then to a wet pre-flash tower (3).** The overhead products of the two pre-flash towers are then fractionated as required in a gas plant and rectification towers (4). The topped crude, typically reduced by  $\frac{2}{3}$  of the total naphtha cut, is then heated in a conventional heater and conventional topping column (5). If necessary the reduced crude is fractionated in one deep vacuum column (6) designed for a sharp fractionation between vacuum gas oil, two vacuum distillates and a vacuum residue, which could be also a road bitumen.

Technip Energies has been pioneering the development of progressive crude distillation, where the addition of pre-flash columns limits high-temperature heating levels, fosters heat integration, and lowers CAPEX. In revamp projects, the progressive distillation concept is an efficient and economical solution for greatly increasing the crude capacity of existing units without replacing or modifying any major equipment items such as heaters, main towers, overhead condensing systems or feed pumps.



**Extensive application of pinch technology optimizes heat recovery, enabling to minimize heaters as well as air and water cooler duties.**

The use of latest available equipment technologies for heat exchangers, tower internals (trays, grids, random packing, and structured packing ) and vacuum system, as well as the focus given to furnace and transfer line designs have demonstrated superior overall process performance in terms of product quality, distillate recovery, energy efficiency while enabling CAPEX savings.

The process is particularly suitable for large crude capacity, i.e., above 200,000 bpsd. It is also

available for condensates and light crude progressive distillation with a slightly adapted scheme.

**Advantages**

- Progressive distillation concept can be implemented for revamps, enabling to increase capacity without modifying major equipment such as fractionation columns and heaters
- Whether for grass-roots or revamps, improves the energy efficiency index of the unit and contributes to lowering its CO<sub>2</sub> emissions per ton of crude processed
- Highest performance in terms of product fractionation and quality.

**References**

- Technip Energies has completed more than 120 grassroots or revamp projects for atmospheric and vacuum crude distillation units primarily based on in-house technology.
- The capacity of recent grassroots units (designed or started in the latest five years) ranges from 60,000 to 400,000 bpsd.
- A revamp project currently in operation, using the progressive distillation concept, shows an increase of crude processing capacity of 30% without heater addition.

**Contact**

Alban Sirven  
Refining Product Line Leader  
alban.sirven@ten.com



## Application

- Selective conversion of a wide range of feedstocks ranging from heavy residue to VGO into light olefins, particularly propylene, isobutylene, and ethylene.

## Technology ownership

- Proprietary Technip Energies technology

## References

- Technip Energies has licensed 8 units with propylene yields greater than 18 wt%

## Contact

Raj Singh  
Senior Principal Technologist  
raj.singh@ten.com

For information, email us at:  
fcc@ten.com



# PropyleneMax™ Catalytic Cracking (PMcc™)

PMcc is an advanced fluidized catalytic cracking (FCC) process with a unique integration of process, hardware and catalyst technologies, resulting in higher propylene yields than other currently available technologies. The PMcc process focuses on providing greater feedstock flexibility, higher conversion and maximum propylene yield. In addition, PMcc can easily be tailored to meet a client's needs for ethylene or gasoline.

PMcc selectively cracks a variety of hydrocarbon feedstocks to light olefins, particularly propylene (demonstrated up to 22 wt% FF), isobutylene, ethylene along with aromatic naphtha. Typical feedstocks include distillates, vacuum gasoils and residual oils. Developed through a joint effort, W.R. Grace & Co. (Grace) and Technip Energies offer an improved catalyst and process designed to provide better pathways to increase conversion of crude oil to petrochemical feedstocks. This collaboration combines Grace's knowledge as the leading supplier of FCC catalyst and light olefins additives with Technip Energies' expertise in high propylene and resid catalytic cracking process technology and leading credentials in FCC mechanical design. The joint R&D program ensures that our licensees continue to have state-of-art high olefin FCC technology.

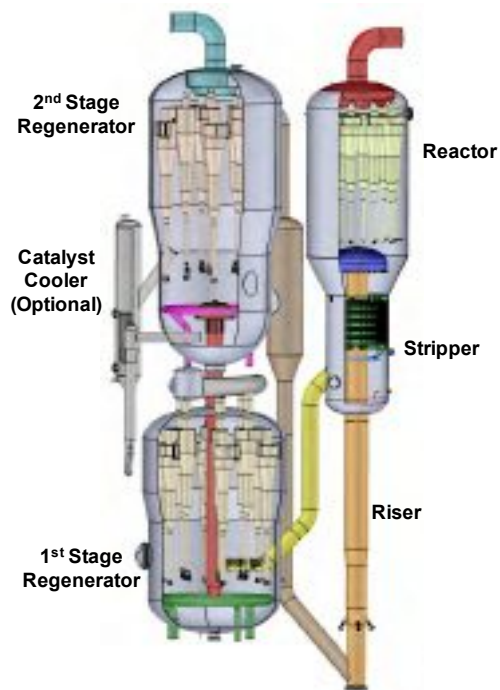

While the PMcc flow scheme and operation are similar to conventional FCC or residue fluid catalytic cracking (RFCC) units, there are key design features that help to produce higher yields of petrochemicals:

- Higher severity operation
- Lower hydrocarbon partial pressure
- Higher residence time to convert naphtha to propylene
- Potential to recycle C4s, LCN and Oligomers to maximize propylene
- Grace light olefins catalyst with dual zeolite functionality from USY and pentasil zeolites
- Single or two stage regeneration depending on feedstock
- Reliable proprietary components

Technip Energies has a proven background in providing high propylene units. PMcc offers a reliable, low-cost route to propylene production and allows the refiner to extend the market range into higher margin petrochemicals. There are several integrated complexes with Technip Energies high olefin FCC or PMcc technology operating successfully.





# Circular Technologies







# Circularity



## Application

Pyrolysis Gas Product Purification for Steam Cracker Integration

## Technology Ownership

Proprietary Technip Energies technology

## Contacts

Andreas Bormann  
VP Sustainable Chemistry  
Product Line and  
Managing Director, Frankfurt  
andreas.bormann@ten.com

James Starr  
Project Manager  
[james.starr@ten.com](mailto:james.starr@ten.com)



# Pure.rGas™

Pure.rBrine™  
by TEN

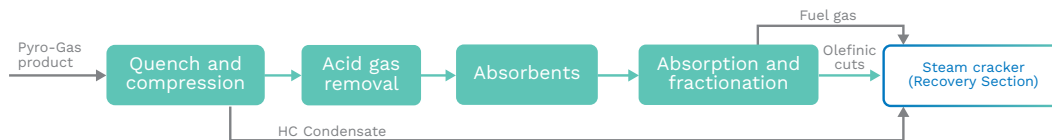

**Among all the advanced plastic waste recycling techniques using the concept of pyrolysis (thermal decomposition in the absence of oxygen), those exporting product gas present some significant differentiators. Indeed, the best in class pyrolysis gas technologies offer a high content of light olefins.** There is no need for extra cracking within a furnace and direct connection to recovery section of an existing steam cracker or to a standalone ethylene recovery unit is possible once adequate safety measures are implemented.

Purpose of Pure.rGas purification train is to bridge this gap by tackling the dual concern of being able to capture the high value compounds while managing the presence of contaminants. The high value compounds inherently present in the plastic pyrolysis product gas are ethylene, propylene, butadiene and BTX. Paraffins will act as olefins yield booster once recycled to extinction together with usual cracker recycles. Light end fraction is a mixture of methane, hydrogen, and nitrogen.

A various range of contaminants prone to induce negative effects on the steam cracker needs to be mitigated (NO<sub>x</sub>, CO, metals, chlorides, HCN, acid gases, oxygenates, sulfur compounds, etc.). The purification strategy consists of a dedicated multilayer contaminant removal scheme with several level of safeguard for key components like carbon dioxide, hydrogen sulphide, ammonia, chlorides, oxygenates, metals, etc. It maintains the operability of the steam cracker unchanged by allowing:

- the mitigation of fouling and corrosion issues
- a final on-specification product
- poison-free operation of ethylene plant catalysts

Primary driver that has led to Pure.rGas flowscheme is safety of the ethylene recovery section. To achieve this purpose, a liquid absorption of light ends to fractionate the light components (including NO and CO) from the main olefinic streams is implemented. This feature is convenient for integration in any type of steam cracker arrangement:

- For front-end demethanizer scheme (back-end hydrogenation), the removal of nitrogen oxides (NOx) is mandatory before feeding the main cold box as one main concern with cryogenic recovery of ethylene is the hazard linked to the presence of NOx if mixed with butadiene and/or NH<sub>3</sub>. These compounds create solids (NOx gums/salts) at very cold temperature (especially below -100°C) which can then explode when reheated. The absorption used in the Pure.rGas purification train is based on a liquid absorption taking places in mild cryogenic conditions which eliminates such risk.
- For front-end deethanizer or depropanizer scheme (front-end hydrogenation), the acetylene converter is quite sensitive to runaways in case of CO fluctuations. By its nature the pyrolysis product gas will undergo some fluctuations due to the variability of the waste being processed. It is then a must to ensure the integration of a CO-free olefin product to mitigate such kind of risk.

### Advantages

- Minimized carbon footprint offered by the single-step light olefins production plus the Pure.rGas purification which unlock the inherent challenges associated to their recovery
- Technology can act as olefins capacity adder for the existing steam cracker and/or as fossil feedstock replacement
- Key know-how brought by our unique expertise in both ethylene technology and Refinery Off Gas (ROG) treatment technology which faces similar purification challenges
- Processing steps already proven in industry at large scale, as demonstrated by our proven track records in ROG projects
- Flexibility for connection with any kind of steam cracker (gas/liquid/back-end scheme/front-end scheme)
- Resilience towards potential pyrolysis gas product fluctuations
- Multiple synergies with cracker

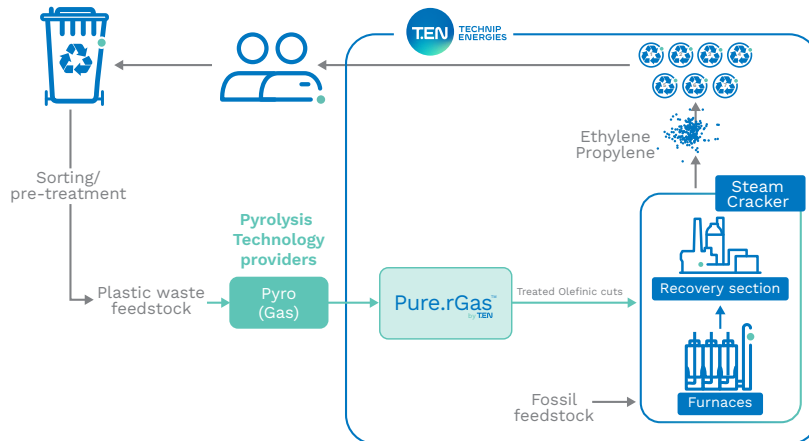

## Application

Purification of pyrolysis oil (from plastic waste) to be used as feedstock into ethylene crackers

## Technology Ownership

Proprietary Technip Energies technology

## Contacts

Andreas Bormann  
VP Sustainable Chemistry  
Product Line and  
Managing Director, Frankfurt  
andreas.bormann@ten.com

Jim Middleton  
Ethylene Product Line Leader  
[jim.middleton@ten.com](mailto:jim.middleton@ten.com)



# Pure.rOil™

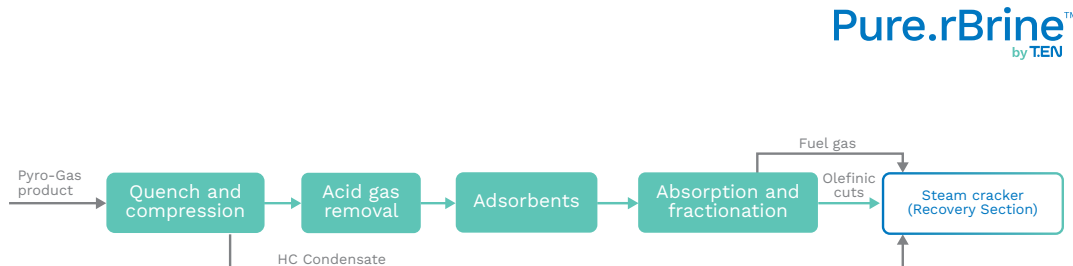

Pure.rBrine™  
by T.EN

### Integrating pyrolysis oil from plastic waste into an existing steam cracker feed is a challenge that needs to tackle the dual concerns of a potential heavy oil tail, while managing the presence of contaminants.

The extent of the tail and the contaminants present vary, depending on the nature of the feed to the pyrolysis unit and the pyrolysis technology. If untreated, the heavy tail in the oil feedstock can exceed the end point specification for existing furnaces, but removal of this heavy material can cause fouling

problems in the separation equipment and if not processed adequately will give rise to a new waste stream from the cracker.

Various contaminants which can have negative effects on the steam cracker need to be removed or reduced to acceptable levels (e.g., nitrogenated compounds, metals, chlorides, oxygenates, sulphur compounds). Hydrogenation for saturation of olefins and some contaminant removal is based on commonly available technologies from selected and qualified catalyst suppliers.

The purification strategy comprises a dedicated multilayer contaminant removal scheme with several levels of safeguard for key components including chlorides, oxygenates, metals, etc. It maintains the operability of the steam cracker unchanged by allowing:

- The mitigation of fouling and corrosion issues in the furnaces
- A final product on-specification
- Poison-free operation of ethylene plant catalysts

Incorporating Pure.rOil by T.EN provides ethylene producers with a flexible, reliable and circular alternative to feedstock from fossil sources, with the added benefit of TEN being able to truly optimise the circular feedstock by incorporating the modelling of the furnaces and cracker whilst designing the system.

The principal sources of the technology used are:

- Technip Energies' Chloroff technology, developed and implemented many years ago for the clean-up of spent lube oil
- Hydrogenation technologies and catalysts tested on actual oil samples
- Technip Energies' quench technology, used on a large number of operating liquid cracking plants
- Ripple Trays™ used as the tray of choice in many fouling systems in ethylene plants

### Advantages

- Key know-how brought by Technip Energies' expertise in ethylene technology.
- Processing steps already proven on a unitary basis in industry at large scale, as demonstrated by our strong track records in ethylene quench system projects and deep knowledge of fouling mechanisms.
- Ability to model the impact of the feed on furnaces using proprietary SPYRO® software.
- Well-established relationships with the key hydrogenation catalyst suppliers

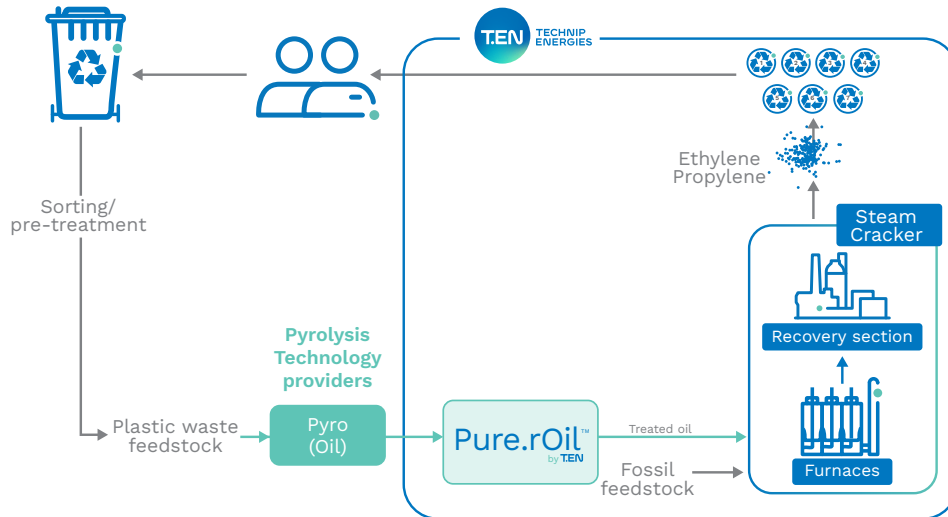



## Application

Agilyx's depolymerization technology breaks down waste plastic polymers into their respective discrete monomers. Polymers, such as polystyrene, are depolymerized by a pyrolysis reaction. The pyrolyzed gas product is quenched and the result is an Agilyx Styrene Oil (ASO). ASO is purified by a Technip Energies purification process into a styrene monomer product. This styrene monomer can then be used as feedstock to existing polymerization processes to create new virgin-equivalent polymer materials.

## Technology Ownership

- Agilyx has a proprietary technology for the pyrolysis process
- Technip Energies has a proprietary purification process for the Styrene Oil from the Agilyx process.
- Technip Energies exclusively licenses the full pyrolysis/purification solution.

## References

- Agilyx currently operates a pyrolysis demonstration unit in Tigard Oregon, USA. Production capacity is 10 tons per day of ASO.
- Technip Energies, through Badger Licensing, has significant experience in licensing Styrene Monomer technology via the ethylbenzene dehydrogenation route, including Styrene Monomer purification technology.

## Contacts

Agilyx: Chris Faulkner  
Chief Technology Officer  
chris.faulkner@agilyx.com

T.EN: Peter Vallieres  
Licensing Technology Manager  
peter.vallieres@ten.com



# TruStyrenyx™ Recycled Polystyrene to Styrene Monomer process

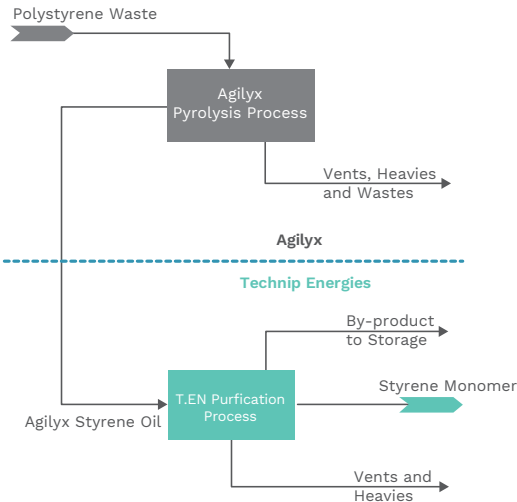

TruStyrenyx™



## Differentiators:

Agilyx has demonstrated its pyrolysis technology at its own facility in Tigard, Oregon which has a capacity of 10 tons per day. The seventh-generation unit has over 16,000 hours of operations and converted over 4,400 tons or 8.9 million pounds of mixed waste plastic and polystyrene waste. This exceeds the current capabilities of any active competitor.

The Technip Energies purification technology is based on its know-how from the Styrene Monomer technology. The technology for the purification of Agilyx Styrene Oil has been pilot tested in Technip Energies' Research Center in Weymouth, MA USA.

Together, Agilyx and Technip Energies have the only full pyrolysis/purification solution for the recycling of polystyrene post use waste back to valuable monomer products.

**The Agilyx technology consists of three primary systems: feedstock preparation, pyrolysis reaction, and product quench and separation. The core of the Agilyx process conducts the pyrolysis of plastic feedstocks at moderately high temperatures, converting to more valuable products.** The Technip Energies purification technology takes the Styrene Oil from the Agilyx process and purifies it to a highly pure styrene monomer product. The resulting styrene monomer can be fed directly into polymer production facilities.



# Recycling of Polyamide 6 (rPA)

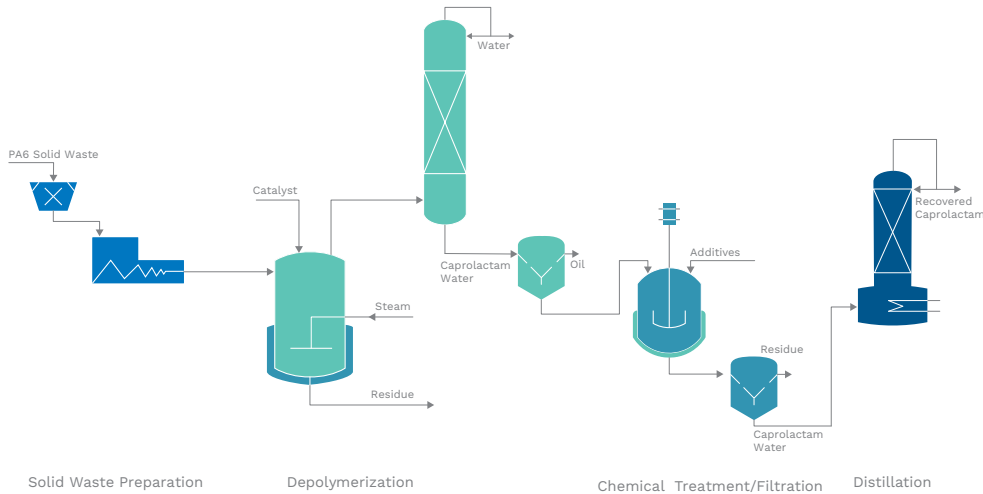

**Zimmer has over 30 years of experience recycling polyamide materials, where solid waste is converted back to high purity monomer that exceeds typical raw feedstock!** This technology builds upon our patented Flexi-Recovery® technology providing a cost-effective solution whilst reducing the overall carbon footprint of the final polyamide products.

Polyamide 6 is the preferred material in many applications, e.g. Automotive, packaging, infrastructure, textile & fishing gear industries due to its elasticity, high tensile strength, high abrasion resistance & high chemical resistance. However, these same properties also impede biodegradation leading to persistence and accumulation in landfills and the

environment. Consequently, with higher raw materials costs and more environmental regulations there is a strong and growing driver to reuse, repurpose and recycle polyamide waste.

Mechanical recycling is a cost effective for many polymers and is currently the most used solution for polyamides. However the elevated temperatures and mechanical stretching lead to partial degradation of polyamide chains and the production of material with inferior properties. Incineration for energy recovery is also problematic due to the creation of toxic gases, release of captured CO<sub>2</sub> into the atmosphere and loss of valuable caprolactam.

## Application

Recovery of raw materials from various PA sources.

## Technology ownership

Proprietary Technip Energies technology

## References

- First recycling plant started in Premnitz in 2000.
- Various capacities up to 60 tpd.

## Contact

Stefan Deiss  
 Head of Product Management and R&D  
[stefan.deiss@ten.com](mailto:stefan.deiss@ten.com)





PA 6 plant with solid waste recycling

Ideally for successful chemical recycling, the source and composition are well known e.g. Fishnets/ production waste.

First, the polyamide 6 must be separated from other polymers, ground into pellets and washed to remove contaminants. The polyamide 6 is then depolymerised back to caprolactam, purified and recovered for production of new polyamide 6 products. Significant cost and process efficiencies can be achieved when solid recovery is combined with waste recovery from a polyamide 6 production facility.

#### **Advantages**

- Economic recovery of high value raw materials.
- Reduced carbon footprint.
- Reliable & Proven technology.

# Decarbonization Solutions







# Decarbonization



## Application

Shell's CANSOLV® CO<sub>2</sub> Capture Technology is a regenerable process that uses a proven proprietary amine solvent to capture diluted CO<sub>2</sub> from the flue gases of power generation and industrial emission sources, and then release it as a pure stream. CANSOLV® amine offers cutting-edge performance, including low parasitic energy consumption, fast kinetics and extremely low volatility

## Technology ownership

- Shell Catalyst & Technologies

## References

- Boundary Dam coal fired power station in Saskatchewan, Canada.
- Around 1 million tonnes of CO<sub>2</sub> a year is captured from high CO<sub>2</sub> concentration flue gas of Boundary Dam Power Plant's 160MW Unit 3. The captured CO<sub>2</sub> is used for enhanced oil recovery in nearby oil fields and then permanently stored underground.

## Contacts

Milton Keynes Operating Center  
+44 (0)1908 203 300

Manuel Jacques  
Early Engagement Manager  
manuel.jacques@ten.com

Myrian Schenk  
Technology Manager  
myrian.schenk@ten.com



# Shell's CANSOLV CO<sub>2</sub> Capture Technology

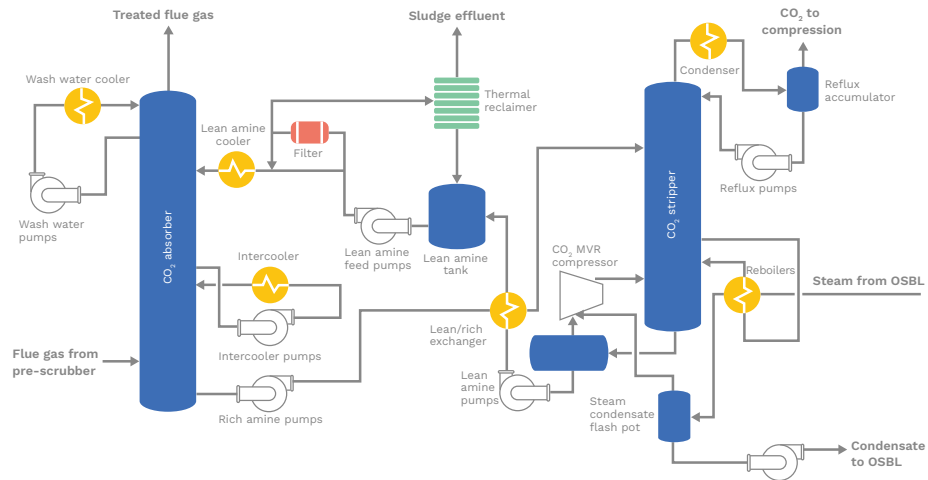

**Pre-treated flue gas from an industrial source is fed into the CO<sub>2</sub> Absorber, where CO<sub>2</sub> in the flue gas is selectively removed by counter-current contact with advanced amine solvent in a packed-bed.** The treated flue gas then passes through a water wash section that captures volatile or entrained amine droplets before is released to the atmosphere. The amine solvent is then transferred to the CO<sub>2</sub> Stripper, where heat is provided in the reboiler to regenerate the solvent and recover CO<sub>2</sub> at the top. The regenerated solvent is eventually returned to the absorber, closing the solvent loop in the capture process.

Shell's CANSOLV® CO<sub>2</sub> Capture Technology is proven at large-scale and is easily retrofitted onto existing industrial emission sources to produce relatively pure CO<sub>2</sub>. High CO<sub>2</sub> capture rates, modularized units, lower energy penalties (leading to lower operating costs) and simple/reliable operation, are also notable characteristics.

The captured CO<sub>2</sub> can be exported in gaseous or liquified form.



# Gas and Low Carbon Energies







# Gas Processing/LNG



## Application

- A high efficiency cryogenic process for gas fractionation to recover C2 and/or C3+ hydrocarbons from natural gas using different process configurations depending on project objectives.

## List of main patents

- US 4,690,702 / US 5,114,450 / US 7,458,232 / US 2010/0242536 / US 4,689,063 / US 5,566,554 / US 6,578,379B2 / US 9,316,434

## References

- >30 CRYOMAX® installed as of today mostly in the frame of Technip Energies' FEED/EPC contracts corresponding to >50 trains. Locations include Australia, Libya, Qatar, Russia, Saudi Arabia, UAE and other countries

## Contacts

Phil Hagyard  
VP LNG Product Line  
philip.hagyard@ten.com

Jérémie Esquier  
Cryomax® Licensing Manager  
jeremie.esquier@ten.com



Khursaniyah Gas Plant, Kingdom of Saudi Arabia - 1 BSCFD CRYOMAX unit

# CRYOMAX® - NGL Recovery Technology

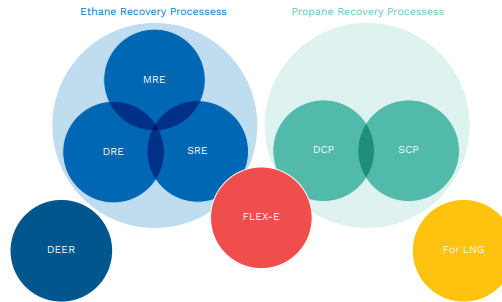

## CRYOMAX technology offers different process configurations:

- Single Reflux Ethane: 70% to 90% level of C2 recovery
- Dual and Multiple Reflux Ethane: up to 99% C2 recovery
- Flex-E: from low to high C2 recovery at constant 99%+ C3 recovery
- Single Column Propane: Reduced compression power at constant propane recovery
- Dual Column Propane: Deep Propane Recovery (> 99%) at low compression power
- DEER: latest scheme developed for revamping
- For LNG: NGL extraction in LNG plant

## MRE flow scheme

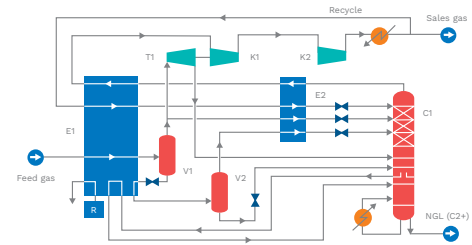

## Advantages:

- Technip Energies covers all phases from concept up to EPC start-up
- EPC execution feedback and operation experience incorporated in our design
- Reduced CAPEX thanks to an excellent knowledge of key equipment and manufacturers (turboexpanders, plate-fin exchangers and distillation columns)
- Reduced OPEX thanks to optimized thermal integration, resulting in lower utility consumption
- Very high C2 and/or C3 recovery up to 99% (if required)
- No proprietary equipment

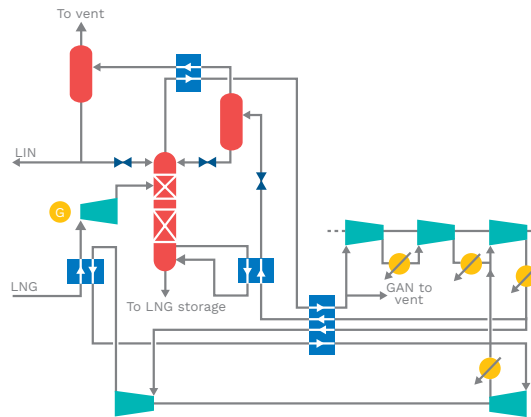

In the refrigeration cycle, a gas expander is used to sub-cool a part of the LNG from the main cryogenic heat exchanger. An open heat pump is used to produce high-purity nitrogen, during which a helium-rich stream is rejected.

The fractionation of methane and nitrogen occurs at cryogenic temperature. This process has been designed with extensive thermal integration to minimize power consumption. The heat pump allows for the reflux flow to be condensed by recovering the cold energy from the reboiler of the column.

Using a reverse Brayton cycle, the refrigeration loop controls the temperature of the column feed stream, which allows the reboiler to manage the required reflux flow and condenser duty. This balances the overall cold required for the fractionation of the nitrogen.

### Advantages:

- Reduced environmental impact due to the very low methane content (0.1 mol%) in the rejected nitrogen
- Maximized production of LNG for a given refrigerant compressor power
- High-purity nitrogen can be produced, either under gaseous or liquid state, to feed the utility network
- Raw helium is produced with a high recovery rate
- Improved economics due to increased LNG production, helium production and a supply of cryogenic-grade nitrogen

### Application

- An end flash, cryogenic process to remove nitrogen from LNG and monetize the helium from natural gas. The process is effective even with trace quantities of helium in the feed gas.

### Technology ownership

- Proprietary Technip Energies technology (US Patent 9,316,434)

### Contact

Phil Hagyard  
 VP LNG Product Line  
[philip.hagyard@ten.com](mailto:philip.hagyard@ten.com)









# Hydrogen



## Application

- Production of H<sub>2</sub> from hydrocarbon (HC) feedstocks, by steam reforming.

## Technology ownership

- Proprietary Technip Energies technology

## References

Technip Energies' H<sub>2</sub> plant technology has been applied in more than 275 plants worldwide. Most installations are for refinery application with basic features for high reliability and optimized cost.

## Contact

Matt Pitcher  
Head of Technology - Hydrogen  
matt.pitcher@ten.com



# Hydrogen

The generic flowsheet consists of feed pretreatment, pre-reforming (optional), steam-HC reforming, shift conversion and H<sub>2</sub> purification by pressure swing adsorption (PSA). However, it is often tailored to satisfy specific requirements.

Feed pretreatment normally involves removal of sulfur, chlorine and other catalyst poisons after preheating to an appropriate level.

The treated feed gas mixed with process steam is reformed in a fired reformer (with adiabatic pre-reformer upstream, if used) after necessary superheating. The net reforming reactions are strongly endothermic. Heat is supplied by combusting PSA purge gas, supplemented by makeup fuel in multiple burners in a top-fired furnace.

Reforming severity is optimized for each specific case. Waste heat from reformed gas is recovered through steam generation before the water-gas shift conversion. Most of the CO is further converted to H<sub>2</sub> in the shift reactor. Process condensate resulting from heat recovery and cooling is separated and generally reused in the steam system after necessary treatment. The entire steam generation is usually on natural circulation, which adds to higher reliability. The gas flows to the PSA unit, which provides high-purity H<sub>2</sub> product (up to < 1 ppm CO) at near-inlet pressures.

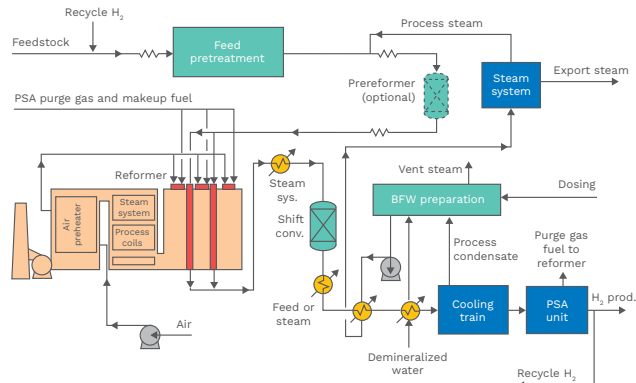

Typical specific energy consumption based on feed + fuel – export steam ranges between 3.0 Gcal/KNm<sup>3</sup> and 3.5 Gcal/KNm<sup>3</sup> of H<sub>2</sub> (330 – 370 Btu/scf) on a lower heating value basis, depending upon feedstock, plant capacity, optimization criteria and steam-export requirements. Advances include integration of H<sub>2</sub> recovery and generation, and recuperative reforming in a Technip Energies Parallel Reformer (TPR®) or by applying EARTH® tubes, both options especially suitable for capacity retrofits.

## Advantages

- Over 50 years of core H<sub>2</sub> competence
- Tailored advanced solutions for high efficiency and cost-effectiveness
- Highest focus on reliability and HSE
- Single-point responsibility from concept to commissioning
- Global alliance with Air Products for “over-the-fence” H<sub>2</sub> plants

# Hydrogen and Carbon Capture (Blue Hydrogen)

The heart of the hydrogen plant is the Technip Energies' reforming technology. This technology

includes the Steam Methane Reformer (SMR) and/or Autothermal Reformer (ATR), recuperative reforming technologies as the TPR<sup>®</sup> and EARTH<sup>®</sup> and NO<sub>x</sub> reduction technologies like the LSV<sup>®</sup> burner and SCR. Technip Energies offers customized solutions to optimally respond to the customer needs. These solutions are available as building blocks, each individually proven, to ensure a flawless engineering process and reliable plant operation. The main building blocks are the feed purification section where a wide range of feedstock can be treated to a quality acceptable for the reforming section; the reforming section itself; shift conversion and final hydrogen purification; including the optimized heat integration between the various process steps.

The design considers feedback from operating companies over the past six decades, including Air Products who operates over 40 plants designed under a global alliance established in 1993. CO<sub>2</sub> capture is a dedicated add-on to conventional hydrogen plants and is preferably applied downstream of the shift conversion, making use of the elevated CO<sub>2</sub> partial

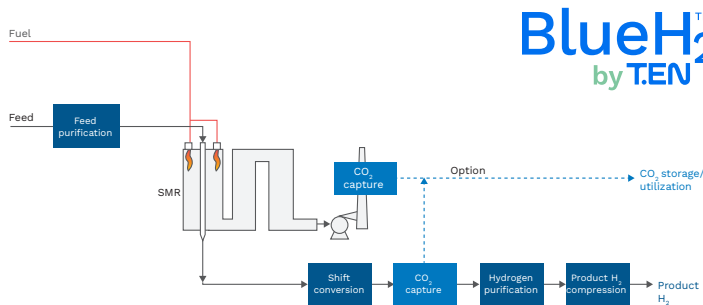

BlueH<sub>2</sub><sup>™</sup>  
by TEN

pressure. In conventional hydrogen plants roughly 60-70% of the total CO<sub>2</sub> emission is attributable to indirect process gas emissions (via PSA purge gas firing) while the remainder is directly emitted via makeup fuel firing. Using hybrid reforming (SMR+ATR), up to 85% of the indirect process gas emissions can be captured while maintaining PSA purge gas and hydrocarbon make-up fuel firing, with lower scope 2 emissions in comparison to a stand-alone ATR scheme. Technip Energies has developed solutions to shift the presence of CO<sub>2</sub> from the flue gas to the process gas, thus increasing the potential for “easy” capture from process gas, achieving scope 1 carbon capture rates in excess of 99%. Scope 2 emissions can be similarly managed by integrating power generation or sourcing low-carbon electricity.

## Advantages

- Strong conceptual engineering background enabling agnostic technology selection for mitigating Scope 1, Scope 2 and Scope 3 carbon emissions
- Blue hydrogen applications by synthesis of well referenced plant sections

## Application

- Hydrogen has wide application in the refining and chemical industries.
- Decarbonization options are available to reduce the CO<sub>2</sub> footprint down to less than 0.1 kg CO<sub>2</sub>/kg H<sub>2</sub> in grassroots as well as brown field applications. Decarbonized Hydrogen is being considered in several other industries like petrochemicals, steel, power, cement etc., as an attractive substitute for feed or fuel as part of the global net zero effort.

## Technology ownership

- Founded in 1963 as SELAS of America (The Netherlands) later known as Kinetics Technologies International (KTI), the Technip reforming technology for top-fired reformers is owned by Technip Energies Process Technology.
- The design will integrate various third-party technologies like catalysts, ATR and Air Separation Unit, PSA purification, flue gas CO<sub>2</sub> capture (Like Shell CANSOLV<sup>®</sup> and BASF OASE<sup>®</sup> blue) and process CO<sub>2</sub> capture. (Like BASF OASE<sup>®</sup> white and DOW/UOP product range).

## References

- Technip Energies reference base includes over 275 hydrogen plants with 50 facilities that include CO<sub>2</sub> capture.

## Contacts

Matt Pitcher  
Head of Technology - Hydrogen  
matt.pitcher@ten.com



## Application

- Production of syngas ( $H_2 + CO$ ) from hydrocarbon (HC) feedstocks by steam reforming.

## Technology ownership

- Proprietary Technip Energies technology

## References

- Technip Energies has been involved in more than 20 syngas plants that produce pure CO or controlled mixtures of CO and  $H_2$ .

## Contact

Matt Pitcher

Head of Technology - Hydrogen  
matt.pitcher@ten.com



# Syngas ( $H_2 + CO$ )

The generic flowsheet consists of feed pretreatment, prereforming (optional), steam-hydrocarbon (+ $CO_2$ ) reforming,  $CO_2$  removal and purification by cold box or pressure swing adsorption (PSA).

However, it is often tailored to satisfy specific requirements.

Feed pretreatment normally involves removing sulfur, chlorine and other catalyst poisons after preheating the HC feed to an appropriate level.

The treated feed gas and recycle  $CO_2$  (from the  $CO_2$  removal section) mixed with process steam is reformed in a fired reformer (with adiabatic pre-reformer upstream, if applied) after necessary super-heating. The net reforming reactions are strongly endothermic. Heat is supplied by combusting purge gas from the purification system, supplemented by makeup fuel in multiple burners in a top-fired furnace.

Reforming severity is optimized for each specific case. Waste heat from the reformed gas is recovered through steam generation. Process condensate resulting from heat recovery and cooling of the reformed gas is separated and generally reused in the steam system after necessary treatment.

After cooling, the reformed gas is sent to the  $CO_2$  removal section, where  $CO_2$  is removed from the

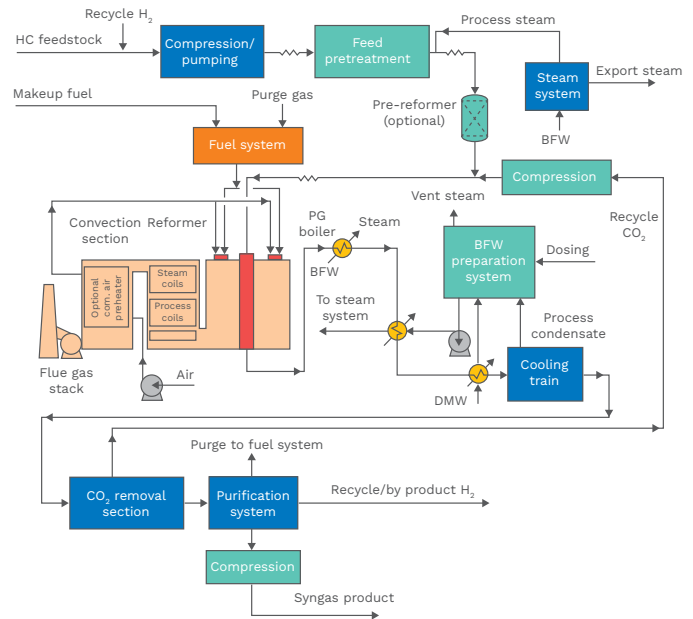

reformed gas before it enters the purification system to produce the desired quality of syngas. The entire steam generation is usually on natural circulation, which adds to higher reliability.

## Advantages

- Full integration of reforming and syngas purification steps
- Process scheme optimization based on detailed capex/opex analysis

# Co-generation of power

(for production of hydrogen, syngas or reducing gas)

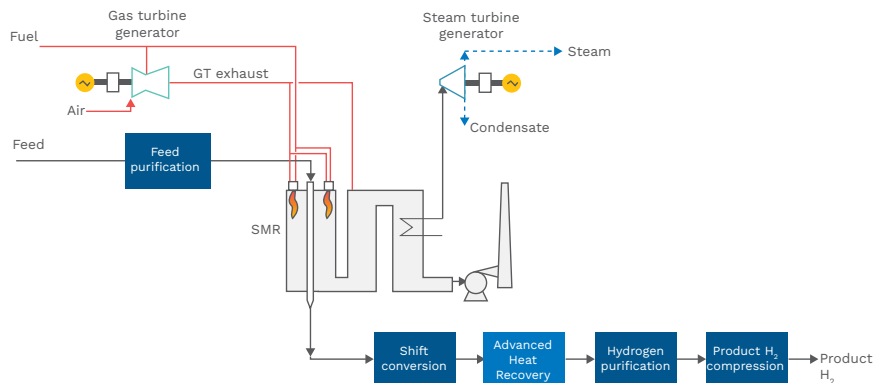

**In the production of hydrogen and syngas, excess heat is available from the combustion gases of the reformer as well as the process gas.** Due to abundant heat available from the process gas at intermediate temperature level, boiler feed water can be heated without the need for incremental fuel combustion. Hence, this provides a unique opportunity to reduce the facility CO<sub>2</sub> production by shifting the duty from on-purpose boilers to the syngas generation section.

In on-purpose power generation heat is recovered from the gas turbine exhaust in the HRSG (Heat Recovery Steam Generation) to produce incremental steam for additional power generation by steam turbines. The main efficiency loss of the “combined cycle” is related to the heat content of the flue gas

discharged to stack with a high oxygen content, which is intrinsic to gas turbine operation. This stack loss can be significantly reduced by utilizing the gas turbine exhaust in the reformer furnace (as replacement for the combustion air), including the HRSG in the convection section of the reformer. In this arrangement the flue gas oxygen content is substantially reduced, resulting in an improved economy of scale and lower operational expenditure.

## Advantages

- Full integration of reforming and power generation from steam and/or gas turbines
- Process scheme optimization based on detailed capex/opex analysis

## Application

- Hydrogen: syngas and reducing gas facilities utilizing reformer technology may be installed in locations where a reliable power source is available in inadequate quantity or locations that economically favor the co-generation of electric power.

## Technology ownership

- Founded in 1963 as SELAS of America (The Netherlands), later known as Kinetics Technologies International (KTI), the Technip Energies reforming technology is owned by Technip Energies Process Technology.
- The technology range includes the integration of gas turbines and steam turbines within the facility to co-generate power.

## References

- Several references are available for the integration of gas turbine exhaust as replacement of combustion air in reformers: India (2); Australia (1) and USA (3).



- In addition, the generated excess steam in the SMR can be adjusted in terms of conditions (up to 130 barg / 500°C) and quantity to satisfy the power demand of the facility by direct drive turbines for equipment or power generation for export or internal users utilizing back pressure and condensing turbines with or without steam extraction at intermediate pressure level. The reference base includes one facility in India and three facilities in the USA as well as many references where the power generation was outside Technip Energies' scope.

#### Contact

Matt Pitcher  
Head of Technology - Hydrogen  
matt.pitcher@ten.com



# Steam Methane Reformer

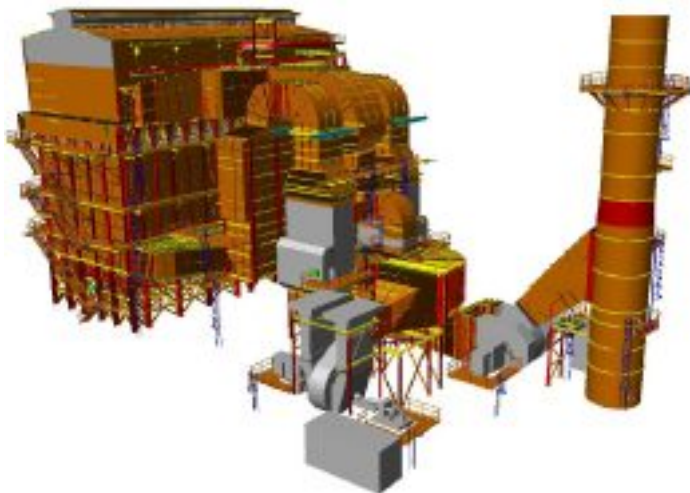

**The reformer is typically a top fired configuration, though for lower capacities bottom and side fired configurations are available.** The design is intrinsically safe, with steam generation in the process gas boiler and flue gas boilers based on natural circulation. The convection section design can be accommodated in various configurations (vertical, up-over, horizontal and rotated horizontal), and selected based on local conditions (local construction costs, plot space available, client preference).

Reformer reliability and performance is strongly related to the heat flux pattern on the catalyst tubes, associated with the burner heat release pattern. The Technip Energies proprietary software has been fine-tuned against plant operational data

in hydrogen plant and steam cracker applications across the world for over five decades. For new projects, the intended burners can be tested in Technip Energies' own burner test facility, allowing accurate validation of the burner heat release pattern.

Modern day reformers are typically designed for efficiencies in the 90's by improving feed and flue gas distribution in the radiant section and improving the heat pick-up in the convection section to make steam or air preheat. Reformer convection sections can be designed with deNOx systems to comply with regulatory requirements on NOx emissions compliance. Computational Fluid Dynamics (CFD) is routinely applied to optimize performance of various components in a reformer.

## Application

- The Steam Methane Reformer (SMR), often referred to as the Reformer, converts a mixture of hydrocarbons and steam to a mixture of carbon oxides, methane and hydrogen ("Syngas") and is used in hydrogen, methanol, ammonia, reducing gas industry and Gas-to-Liquids (GTL) flowsheets.
- The typical scope of engineering design and supply is the reformer package, which comprises of other proprietary and non-proprietary equipment (Burners, Process Gas Boilers, Steam Drum, Fans, etc.).
- The reformer package reference base includes several reformer packages in plants licensed by other technology providers.

## Technology Ownership

- Founded in 1963 as SELAS of America (The Netherlands), and later known as Kinetics Technologies International (KTI), the Technip Energies reforming technology is owned by Technip Energies Process Technologies.
- Additional technologies include associated proprietary equipment: Steam Drum, Process Gas Boiler (PGB), LSV® burners and recuperative reforming technologies like EARTH®, ART & TPR®
- Technip Energies Process Technologies also owns the proprietary process design software (SPYRO®) for design and rating of the above-mentioned reformer package components.

## References

- More than 275 SMR's installed from small (~ 10 tubes) to large (> 700 tubes) capacity range
- Multiple world scale capacity reformers (more than 700 tubes)
- Alliance with Air Products and Chemicals (APCI)

## Contact

Matt Pitcher

Head of Technology - Hydrogen

[matt.pitcher@ten.com](mailto:matt.pitcher@ten.com)



Large scale reformer



Mid scale reformer

# EARTH<sup>®</sup> - Enhanced Annular Reforming Tube for Hydrogen

EARTH<sup>®</sup> is a drop-in insert consisting of a structured reforming catalyst and concentric flow tubes, installed in existing or new reformer tubes, to simultaneously achieve higher throughput and heat recovery in steam reformers. EARTH<sup>®</sup> is a novel, recuperative steam reforming technology which facilitates efficient recovery of high-grade heat inside the main reformer tube. Technip Energies and Clariant have joined their collective expertise to develop and deliver EARTH<sup>®</sup> technology to the market, comprising this proprietary geometric layout in combination with a highly active, stable and mechanically robust catalyst that promotes efficient and optimized heat transfer as well as low pressure drop.

EARTH<sup>®</sup> technology is advantageous for achieving a capacity increase of up to +20% with no or minor modifications on the steam reformer furnace and it enables energy efficiency and up to 10 percent CO<sub>2</sub> emissions reduction compared to conventional steam reforming technologies.

## Advantages

- Higher hydrogen make per catalyst tube
- Drop-in solution for immediate capacity increase without increasing reformer firing

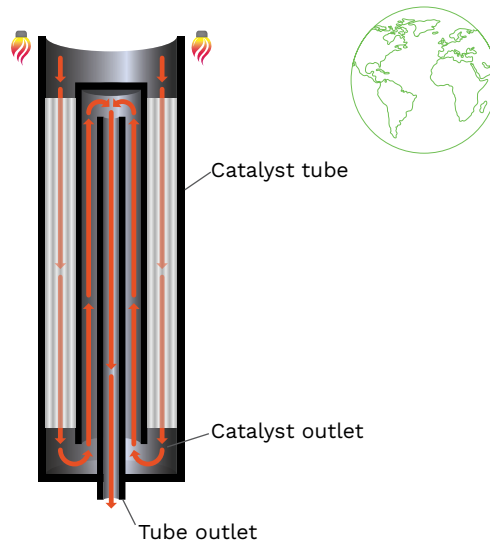

## Application

- Increase Hydrogen and Syngas production
- Enhancing Steam Reformers efficiency
- Reduce Carbon footprint

## Technology Ownership

- Proprietary Technip Energies technology
- Clariant for structured catalyst supply (catalyst co-developed between Technip Energies and Clariant)

## References

In 2019, the first EARTH<sup>®</sup> tubes were implemented in an industrial unit for H<sub>2</sub> and syngas production. Based on the successful results of this prototype application, Technip Energies is awarded a second project, and have several proposals outstanding.

## Contact

Antonio Farace  
Manager, Plant Lifecycle Solutions  
antonio.farace@ten.com



## Application

- Hydrogen plant capacity increase
- Zero-export-steam plants

## Technology Ownership

- Proprietary Technip Energies technology

## References

- Technip Energies has designed and supplied 11 operating TPR® references, with standalone hydrogen generation capacities ranging from 3 to 25 kNm<sup>3</sup>/h

## Contact

Vinay Khurana  
Director, Strategy  
vinay.khurana@ten.com

Antonio Farace  
Manager, Plant Lifecycle Solutions  
antonio.farace@ten.com



# TPR® – Technip Energies Parallel Reformer

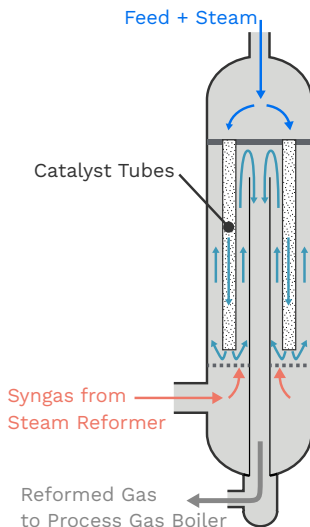

**The TPR® is a reactor in which hydrogen is produced by steam reforming.** Unlike a conventional steam reformer the TPR® is not a furnace, but a vertically placed tubular reactor with reforming catalyst in which the heat of reaction is supplied by a hot process stream at the shell side of the reactor. Typically, the TPR® is placed in parallel to the steam reformer, in such a way that the hot effluent from the steam reformer is used as the heat source for the TPR®.

The shell contains one single tube sheet at the top, to which tubes are welded; the other end is open.

Pre-heated feed gas (natural gas with steam, or pre-reformer effluent) flows from the top of the TPR® through the tubes while the feed is converted to a mixture of hydrogen, carbon monoxide, carbon dioxide, methane and water, analogue to the reactions in the main steam reformer. At the outlet of the tubes the process gas is mixed with hot steam reformer effluent entering at the bottom of the reactor. Subsequently the mixture flows upwards through the refractory lined shell, thereby supplying the heat required for the reforming reaction to the TPR® tube side. A central collector pipe in the middle of the reactor directs the mixture finally back to the bottom of the reactor, where the process gas exits to the process gas waste heat boiler. This concept is referred to as “2 in / 1 out” configuration.

When a steam reformer is combined with an TPR® the overall firing demand is significantly reduced (up to 20–30%), as part of the heat of reaction is supplied from process/process heat exchange. As a consequence, the plant will consume less feed and fuel and will produce less (or even zero) export steam.

## Advantages:

- The TPR® scheme is particularly attractive for revamp/debottleneck applications where a large increase in capacity of the existing hydrogen plant is desired. TPR® has proven to be economically attractive for capacity increments in the 25–30% range.
- TPR® can also be applied to grass-root plants when no need for export steam exists.



# Dual Chamber Process Gas Boiler (PGB)

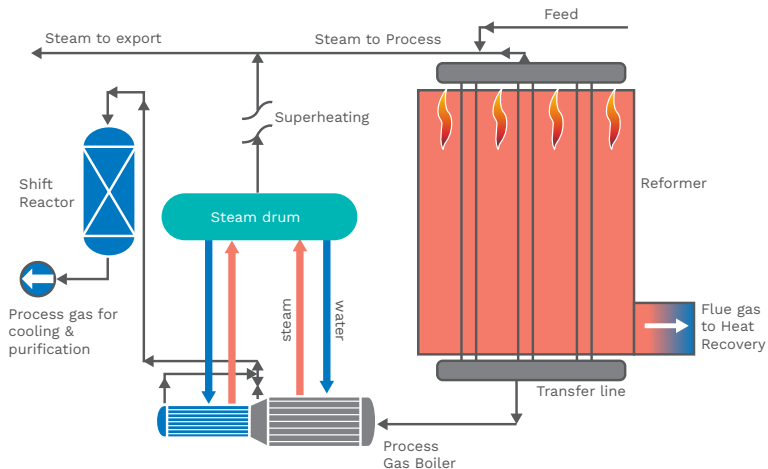

In the steam reformer combustion heat is transferred from the hot flue gas in the firebox to the catalyst tubes where the endothermic hydrogen formation reactions take place. The converted feedstock or process gas leaves the fired section at temperatures typically between 800° and 950°C. The process gas is then cooled in a process gas boiler to the temperature required for entering the downstream water-gas shift section that allows for additional hydrogen production by carbon monoxide (CO) conversion. The heat of the process gas is transferred to boiling water and recovered as valuable high-pressure steam, which may be superheated and used partially as process steam with the balance monetized as steam export.

A significant reduction of material costs associated with heat transfer surface is achieved by optimization of the heat transfer area in each compartment of

the PGB. A reduction of the differential growth between shell and tubes enables the realization of significantly larger units without excessive stress on critical components of the process gas boiler. The external bypass system operates under less severe temperatures, minimizing the risk to metal dusting and other mechanical failures while allowing easier valve inspection and maintenance.

## Advantages

- Engineered heat release pattern
- Optimized flame length keeping high firebox efficiency and low NOx emission

## Application

The Dual Chamber Process Gas Boiler has been designed to provide a cost effective method to recover the heat of the process gas exiting the reformer fired box while cooling down to 360°C and below when desired.

The Dual Chamber Process Gas Boiler is suitable for revamp or grass root steam reformers.

## Technology ownership

- Proprietary Technip Energies technology

## References

- UK, Technip Energies PGB, duty 29.8 MW
- Singapore, Technip Energies PGB, duty 20.4 MW
- Egypt, Technip Energies PGB, duty 26.7 MW
- Turkey, Technip Energies PGB, duty 82.6
- Russian Federation, Technip Energies PGB, duty 82 MW

## Contact

Antonio Farace  
 Manager, Plant Lifecycle Solutions  
[antonio.farace@ten.com](mailto:antonio.farace@ten.com)



## Application

Steam reformers, cracking furnaces and fired heaters.

The Technip Energies' burners feature high capacity and reliability in combination with efficiency and environmental performance regarding emission limits on pollutants like carbon monoxide (CO) and nitrogen oxide (NO<sub>x</sub>).

## Technology Ownership

- Proprietary Technip Energies technology

## References

- Technip Energies has supplied over 5900 TSWB® burners in a total of 18 projects.

## Contact

Antonio Farace  
Manager, Plant Lifecycle Solutions  
antonio.farace@ten.com

Jim Middleton  
VP - Head of Technology - Ethylene  
jim.middleton@ten.com



TSWB® in operation

# Ultra Low NO<sub>x</sub> burners: Technip Side Wall Burner (TSWB®)

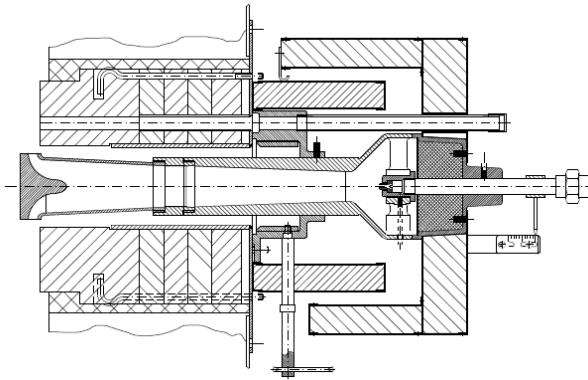

TSWB® drawing

The TSWB® can be applied for different process heating applications and combustion air supply modes (natural draft and induced draft). Moreover it is suitable for a wide range of fuel gas compositions and firing configurations.

The burners are placed in a furnace sidewall (side firing) arrangement and can be combined with the Technip Large Scale Vortex® (LSV®) burner (see insert right).

Technip Side Wall Burners are specifically suited for application in retrofit projects. Replacement of existing burners with Technip burners offers the added possibility to increase capacity and reduce NO<sub>x</sub> emissions.

## Features

Flat flame radiant wall design

Secondary air staging

Robust design

Multi-fuel flexibility

Shielded fuel staging lance

Adjustable and uniform flame heat release profile

## Benefits

Combustion zone expands from burner block to the refractory

Uniformly distributed radiant heat flux

Lower radiant tube wall temperatures

Additional capacity

Low NO<sub>x</sub>

Reliability

Low maintenance

Burner can be used for wide range of processes and fuels

No coking or plugging

Clean tips

Heat release matching process requirements

# Ultra Low NOx burners: Large Scale Vortex (LSV) burner



LSV® burners sketch



The LSV® burner is a cost-effective, low-NOx combustion solution representing Technip Energies' successful track record in design.

It can be applied to different process heating applications and combustion air supply modes (natural draft, induced draft or forced draft). The combustion air may be at ambient temperature or preheated. The burner also is suitable for a wide range of fuel gas compositions and firing configurations. It can be placed on the roof (top firing) or on the floor (bottom firing) of a firebox.

#### Advantages

- Engineered heat release pattern
- Optimized flame length keeping high firebox efficiency and low NOx emissions

#### Application

- Steam reformers, cracking furnaces and fired heaters.
- The Technip Energies' burners feature high capacity and reliability in combination with efficiency and environmental performance regarding emission limits on pollutants like carbon monoxide (CO) and nitrogen oxide (NOx).

#### Technology Ownership

- Proprietary Technip Energies technology

#### References

- Technip Energies has supplied over 1400 LSV® burners in a total of 18 projects.

#### Contact

Antonio Farace  
 Manager, Plant Lifecycle Solutions  
[antonio.farace@ten.com](mailto:antonio.farace@ten.com)



#### Features

Unique nozzle to rapidly dilute fuel  
 Very flexible fluidic flame stabilizer  
 Robust design  
 Multi-fuel flexibility

#### Benefits

Flameless combustion Low NOx  
 Ultra-lean and cool primary flame  
 Reliable  
 Burner can be used for a wide range of processes

Shielded fuel lances  
 Adjustable and uniform flame heat release profile

No coking or plugging Clean tips  
 Heat release matching process requirements Lower radiant tube wall temperature  
 High firebox efficiency

Manufactured by Technip Energies

Quality control  
 Latest developments in burner design applied



T.EN burner test facility

## Application

- Facility wide study on emission sources and potential deNOx solutions
- Standalone systems for Fluid Catalytic Crackers (FCC) units
- Integrated systems for refinery process heaters, ethylene crackers, syngas reformers, ethylene dichloride crackers & gas turbine's with heat recovery steam generation

## Technology ownership

- Integrated solutions involving ultra-low NOx burners and SCR's provided by Technip Energies Process Technology

## References

- Over 90 references of SCR's installed in various heater applications
- Refinery wide NOx abatement study for PBF Torrance, CA to comply with SCAQMD's rule 1109.1
- Integrated SCR with 95% NOx reduction (2 ppmv outlet) for a APCI hydrogen reformer at Texas City, TX, USA
- Integrated SCR with 86% NOx reduction (10 ppmv outlet) for Dow LHC9 ethylene cracker at Freeport, TX, USA
- Standalone SCR with 87% NOx reduction (20 ppmv outlet) for Chevron's FCC unit at El Segundo, CA, USA
- SCR with 93% NOx reduction (9 ppmv outlet) for Dow's 25 MW gas turbine application at Pittsburg, CA, USA

## Contact

Matt Pitcher  
Head of Technology - Hydrogen  
matt.pitcher@ten.com



# DeNOx using Selective Catalytic Reduction (SCR)

**The combustion of fossil fuels results in the formation nitrogen oxides (NOx), a collective name for NO and NO<sub>2</sub>.** These oxides are formed by the thermal reaction between the nitrogen and oxygen in the combustion air (so called thermal NOx) and by the oxidation of fuel bound organic nitrogen (so called fuel NOx).

The Technology of selective catalytic reduction (SCR) of combustion flue gases reduces nitrogen oxides (NOx) into nitrogen (N<sub>2</sub>) and water (H<sub>2</sub>O). This process is a proven technology that relies on a catalyst for the reaction to occur. Reducing agent, usually ammonia, is mixed thoroughly with the flue gas prior to the catalyst. For an effective removal, it's crucial that ammonia be dispersed and mixed throughout the flue gas. Mixing is performed by an injection system which injects pressurized gas-phase ammonia into the flue gas.

SCR catalyst can work under multiple temperature windows and are classified as such (Table 1). Selection depends on the process scheme, economics and regulations governing the application. Medium temperature catalyst are the most common due to its cost and achievable reduction efficiencies.

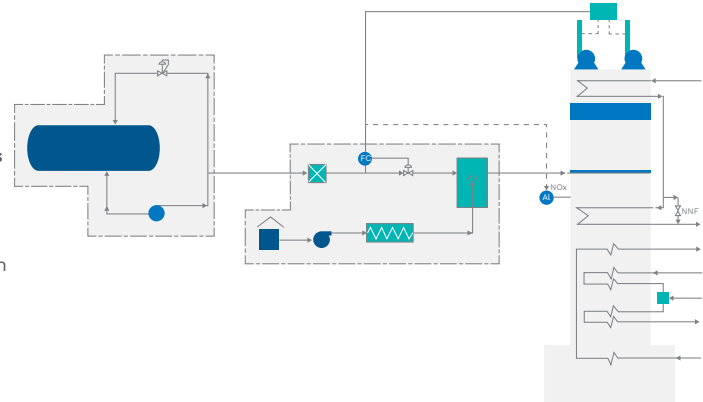

SCR	Operating Temperature	
High temperature	750°F – 1000°F	400°C – 540°C
Medium temperature (Conventional)	550°F – 750°F	290°C – 400°C
Low temperature	350°F – 550°F	180°C – 290°C

SCR's are adaptable to various applications involving process heaters, cracker, reformers, gas turbine exhausts, fluid catalytic crackers etc. as a retro-fit or in a greenfield project.

## Advantages

- Maximum performance based on strong expertise in fluid dynamics
- Stand-alone (bolt-on) as well as integrated solutions

# Operator Training Simulator (OTS)

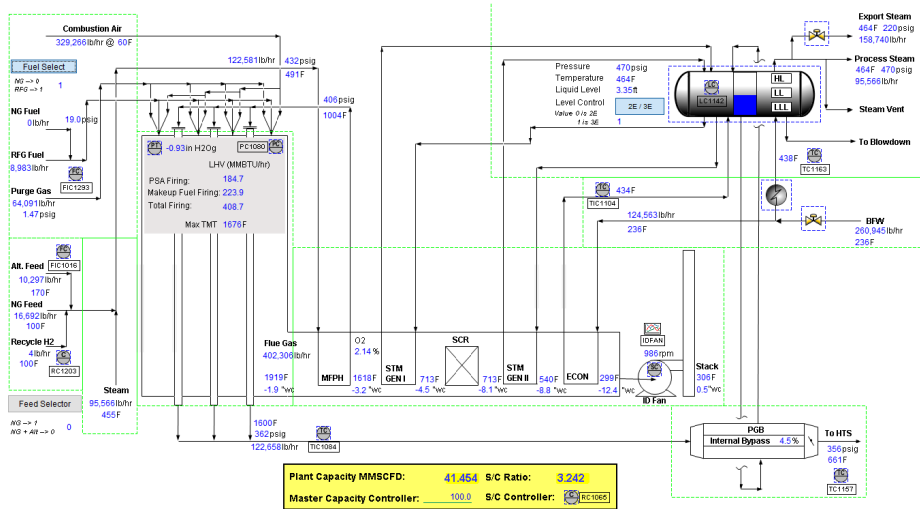

At the core of the OTS is a dynamic process model, complete with hydraulics, liquid holdup, thermal mass, integrated process controls (DCS) and a Safety Instrumented System (SIS). A human machine interface (HMI) is added on top of the model to give operators the look and feel of the actual hardware in their control room thus making the OTS a true digital twin of the operating unit.

Predefined training sessions include cold & hot plant start-up, capacity ramp-up and upset scenarios. The model can be useful for understanding key parameters during transient scenarios. The OTS system consists of a trainer station and trainee station/s. The trainer is in control of the plant

simulator and passes upset scenarios to the trainee who responds to new conditions via the HMI. Test modules are available to provide trainee assessments. The OTS provides a hands-on training opportunity for the board operators before the actual plant startup.

While the primary purpose of the product is as a training tool, process engineers can use the model for what-if analysis, post start-up HAZOP resolutions, future plant efficiency and reliability improvements.

## Advantages

- Embedded know-how of over 50 years of plant design, from concept to start-up
- Realistic simulation capabilities based on rigorous dynamic modeling

## Application

- New operator training and refresher course for operators and process engineers.
- What-if analysis, post start-up HAZOP resolutions, future plant efficiency and reliability enhancements.

## Technology ownership

- integrated solution, which incorporates the process model, controls and shutdown, and operator interface, is provided by Technip Energies Process Technology.

## References

Marathon Petroleum Hydrogen Plant, Dickinson, ND (2020)

## Contacts

Vinay Khurana  
 Director Strategy  
 vinay.khurana@ten.com

Abhijeet Karnik  
 Director Process Engineering  
 abhijeet.karnik@ten.com

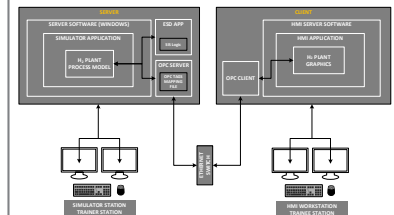





# Research Centers





### Third Party Services

- R&D of proprietary processes, equipment and polymer recipe development
- Sample production/evaluation, process validation and commercialization
- Feedstock and polymer analytics according international standards (ISO, DIN, EN, ASTM)

### Contact

Stefan Deiss

Head of Product Management and R&D  
stefan.deiss@ten.com

Karin Titze-Frech

Head of Analytics and Pilot Plants  
karin.titze-frech@ten.com



# Zimmer® Polymer Technologies Frankfurt, Germany



**Technip Zimmer®'s Research Center is the key innovation driver for Zimmer® Polymer Technologies and is open for cooperation with partners and customers.** The Research Center primarily focuses on polymerization and recycling processes and is uniquely positioned to provide a wide range of R&D services in that area.

Experienced researchers and engineers with access to unique laboratory and pilot plants and state-of-the-art analytical facilities provide services to our customers for all phases of a product development, from business idea to commercialization: generation, testing and optimization of polymer recipes, small scale and mid scale sample production, process development based on lab plant data and process commercialization services.

### Equipment

- Semi-commercial, 1- & 2-stage batch pilot and SSP bench plants for polycondensation
- UV/VIS spectrometer, colorimeter
- Viscosimeter, titrator, coulometer, polarograph
- GC, HPLC, DSC
- Real time reaction monitoring (Online Analytics)



# Badger Process Technology

## Weymouth, MA USA



With a highly experienced staff and a proven track record of successful process commercializations, the Research Center provides bench, pilot, and demonstration scale services for the development of chemical process technologies. Technip Energies' lab and engineering teams work together to generate highly accurate data that allows clients and partners cost effectively extend their research and development capabilities. Most importantly is the access provided to an experienced research team dedicated to the development of novel process technologies.

### Equipment

- Ten 24/7 fully automated pilot plants
- On-line GC and continuous process analyzers
- Fixed, fluid, and trickle bed reactors
- Batch and CSTR systems
- Pressure and vacuum distillation for recycle and product recovery
- Advanced analytical capabilities
- GC FID/TCD, HPLC, GC-Mass Spec
- Ion Chromatography
- VLE Determination
- Corrosion Testing



### Services

- Catalyst activity, selectivity and life testing
- Bench, pilot and demonstration scale testing
- Recycle and product analysis
- Technology evaluation
- Process scale-up and commercialization

### Contacts

Caroline Coton-Tranape  
Director  
caroline.coton-tranape@ten.com



## **USA**

11720 Katy Freeway  
Houston, Texas 77079  
+1 713 870 1111

## **France**

Technip Energies Head Office  
ORIGINE, 2126 boulevard de la Défense, CS 10266  
Nanterre 92741  
France  
+33 (0)1 47 78 21 21

This document is Technip Energies property and it is – together with the information it contains – confidential. It shall not be used for any other purposes than those for which it was supplied and shall not be reproduced and/or disclosed to any third party without Technip Energies authorization. Technip Energies All rights reserved.